

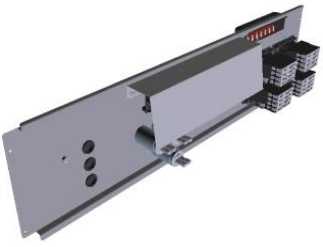





Assembly code	Assembly revision	Assembly image
ASM4098A/0.D00	General overview	
ASM2754B/0.D00	General overview	
ASM2755A/0.D00	External cover	
ASM4080A/0.D00	Door	

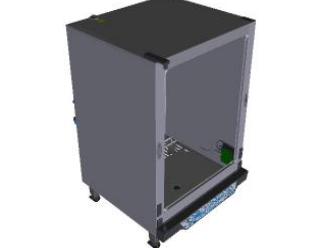

ASM4098A/0.D00 - General overview

FRONT

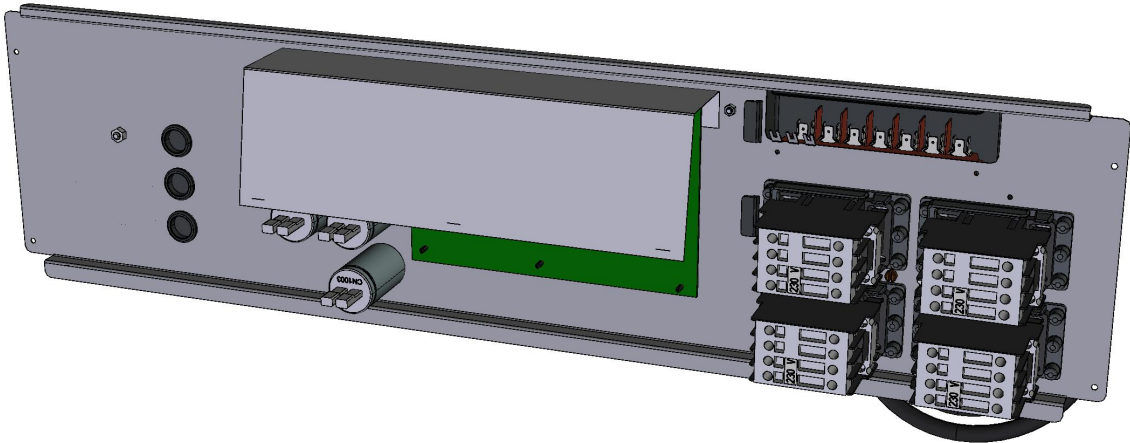





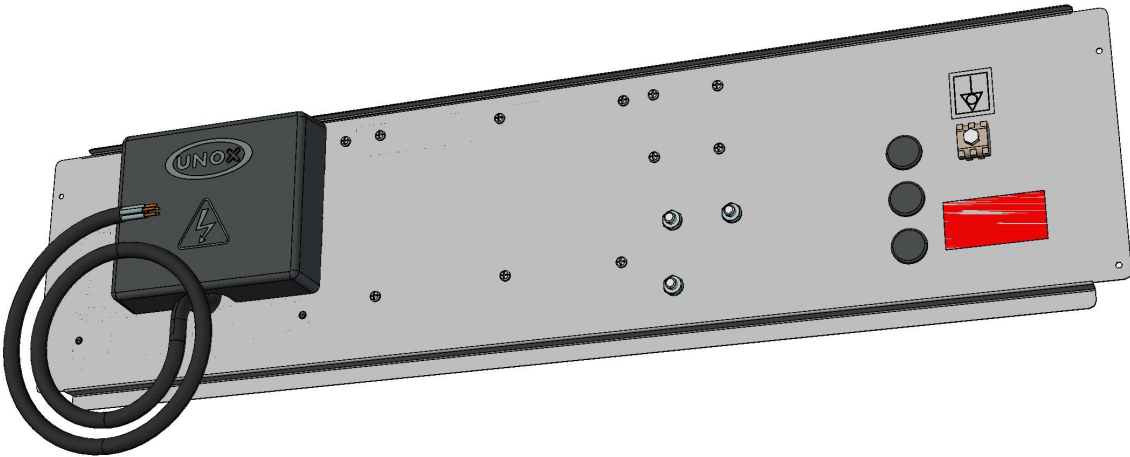

ASM4098A/0.D00 - General overview

REAR

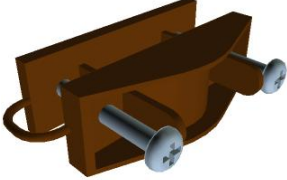

COMPONENT			SPARE PART																		
Code	Description	Image	Code	Description	Components list																
CN1003A	6,3 UF MOTOR CAPACITOR		KCN1003A	6,3 UF MOTOR CAPACITOR KIT	<table border="1"> <thead> <tr> <th>Code</th> <th>Description</th> <th>Qty</th> <th>UOM</th> </tr> </thead> <tbody> <tr> <td>CN1003A0</td> <td>6,3 UF MOTOR CAPACITOR</td> <td>1</td> <td>PZ</td> </tr> <tr> <td>VI1931A0</td> <td>M8 NUT+INDENTE D WASHER D=8 X COND.</td> <td>1</td> <td>PZ</td> </tr> <tr> <td>VI1932A0</td> <td>M8 NUT+INDENTE D WASHER D=8 X COND.</td> <td>1</td> <td>PZ</td> </tr> </tbody> </table>	Code	Description	Qty	UOM	CN1003A0	6,3 UF MOTOR CAPACITOR	1	PZ	VI1931A0	M8 NUT+INDENTE D WASHER D=8 X COND.	1	PZ	VI1932A0	M8 NUT+INDENTE D WASHER D=8 X COND.	1	PZ
					Code	Description	Qty	UOM													
CN1003A0	6,3 UF MOTOR CAPACITOR	1	PZ																		
VI1931A0	M8 NUT+INDENTE D WASHER D=8 X COND.	1	PZ																		
VI1932A0	M8 NUT+INDENTE D WASHER D=8 X COND.	1	PZ																		
VM1750A	BRASS COMB CLAM		KVM1750A	COMB TERMINAL BLOCK KIT	<table border="1"> <thead> <tr> <th>Code</th> <th>Description</th> <th>Qty</th> <th>UOM</th> </tr> </thead> <tbody> <tr> <td>VM1750A0</td> <td>BRASS COMB CLAMP</td> <td>1</td> <td>PZ</td> </tr> </tbody> </table>	Code	Description	Qty	UOM	VM1750A0	BRASS COMB CLAMP	1	PZ								
Code	Description	Qty	UOM																		
VM1750A0	BRASS COMB CLAMP	1	PZ																		
MR1004A	41A 450V 7 POLES TERMINAL		KMR1004A	7FTW 1+2+3/4+5+6 TERMINAL BLOCK KIT	<table border="1"> <thead> <tr> <th>Code</th> <th>Description</th> <th>Qty</th> <th>UOM</th> </tr> </thead> <tbody> <tr> <td>MR1004A1</td> <td>41A 450V 7 POLES TERMINAL</td> <td>1</td> <td>PZ</td> </tr> </tbody> </table>	Code	Description	Qty	UOM	MR1004A1	41A 450V 7 POLES TERMINAL	1	PZ								
Code	Description	Qty	UOM																		
MR1004A1	41A 450V 7 POLES TERMINAL	1	PZ																		
VM2191A	BRACKET FOR BIG CONTACTOR VE109		VM2191A0	BRACKET FOR BIG CONTACTOR VE109																	
VE1095A	GE 25A 230V REMOTE CONTROL SWITCH		KVE1095A	HEATING ELEMENT CONTACTOR KIT	<table border="1"> <thead> <tr> <th>Code</th> <th>Description</th> <th>Qty</th> <th>UOM</th> </tr> </thead> <tbody> <tr> <td>VE1095A0</td> <td>GE 25A 230V REMOTE CONTROL SWITCH</td> <td>1</td> <td>PZ</td> </tr> <tr> <td>VM1075A1</td> <td>PLASTIC CLIP TO FIX CONTACTORS</td> <td>4</td> <td>PZ</td> </tr> </tbody> </table>	Code	Description	Qty	UOM	VE1095A0	GE 25A 230V REMOTE CONTROL SWITCH	1	PZ	VM1075A1	PLASTIC CLIP TO FIX CONTACTORS	4	PZ				
					Code	Description	Qty	UOM													
VE1095A0	GE 25A 230V REMOTE CONTROL SWITCH	1	PZ																		
VM1075A1	PLASTIC CLIP TO FIX CONTACTORS	4	PZ																		



COMPONENT			SPARE PART																										
Code	Description	Image	Code	Description	Components list																								
VE1075A	STRAIN RELIEF FV 268 RO + FIXING SCREWS		VE1075A0	STRAIN RELIEF FV 268 RO + FIXING SCREWS																									
VM1505A	WALL PASSING WITH DIAPHRAGM		KVM1505A	THROUGH-WALL CONNECTION+DIAPHRAGM KIT	<table border="1"> <thead> <tr> <th>Code</th> <th>Description</th> <th>Qty</th> <th>UOM</th> </tr> </thead> <tbody> <tr> <td>VI1220A1</td> <td>4,2X12 TCB SELF-TAPPING SCREW</td> <td>1</td> <td>PZ</td> </tr> <tr> <td>VM1505A0</td> <td>WALL PASSING WITH DIAPHRAGM</td> <td>3</td> <td>PZ</td> </tr> <tr> <td>VM2055A0</td> <td>UPPER THROUGH-WALL CONNECTION</td> <td>1</td> <td>PZ</td> </tr> <tr> <td>VM2056A0</td> <td>LOWER THROUGH-WALL CONNECTION</td> <td>1</td> <td>PZ</td> </tr> <tr> <td>VM2061A0</td> <td>ACCESSORIES CABLES WALL PASSING</td> <td>1</td> <td>PZ</td> </tr> </tbody> </table>	Code	Description	Qty	UOM	VI1220A1	4,2X12 TCB SELF-TAPPING SCREW	1	PZ	VM1505A0	WALL PASSING WITH DIAPHRAGM	3	PZ	VM2055A0	UPPER THROUGH-WALL CONNECTION	1	PZ	VM2056A0	LOWER THROUGH-WALL CONNECTION	1	PZ	VM2061A0	ACCESSORIES CABLES WALL PASSING	1	PZ
Code	Description	Qty	UOM																										
VI1220A1	4,2X12 TCB SELF-TAPPING SCREW	1	PZ																										
VM1505A0	WALL PASSING WITH DIAPHRAGM	3	PZ																										
VM2055A0	UPPER THROUGH-WALL CONNECTION	1	PZ																										
VM2056A0	LOWER THROUGH-WALL CONNECTION	1	PZ																										
VM2061A0	ACCESSORIES CABLES WALL PASSING	1	PZ																										
VM1310A	COVER FOR TERMINAL BLOCK XB/XV/XVC/XG		VM1310A0	COVER FOR TERMINAL BLOCK XB/XV/XVC/XG																									
PE1782A	200-240VAC 12VCC 6VA POWER SUPPL		KPE1782A	LED BAR 200-240VAC 12VCC TRANSFORMER KIT	<table border="1"> <thead> <tr> <th>Code</th> <th>Description</th> <th>Qty</th> <th>UOM</th> </tr> </thead> <tbody> <tr> <td>PE1782A0</td> <td>200-240VAC 12VCC 6VA POWER SUPPLY</td> <td>1</td> <td>PZ</td> </tr> <tr> <td>VM1745A0</td> <td>CARD SUPPORT</td> <td>4</td> <td>PZ</td> </tr> </tbody> </table>	Code	Description	Qty	UOM	PE1782A0	200-240VAC 12VCC 6VA POWER SUPPLY	1	PZ	VM1745A0	CARD SUPPORT	4	PZ												
Code	Description	Qty	UOM																										
PE1782A0	200-240VAC 12VCC 6VA POWER SUPPLY	1	PZ																										
VM1745A0	CARD SUPPORT	4	PZ																										



COMPONENT			SPARE PART																						
Code	Description	Image	Code	Description	Components list																				
0H6771B	BAKERLUX DYNAMIC COMPONENTS HOLDER		0H6771B0	BAKERLUX DYNAMIC COMPONENTS HOLDER																					
PE1810B	BAKERLUX POWER CARD		KPE1810B	CL BL POWER BOARD KIT	<table border="1"> <thead> <tr> <th>Code</th> <th>Description</th> <th>Qty</th> <th>UOM</th> </tr> </thead> <tbody> <tr> <td>PE1810B0</td> <td>BAKERLUX POWER CARD</td> <td>1</td> <td>PZ</td> </tr> <tr> <td>V11850A0</td> <td>M4X6 NICKEL PLATED FIXING SCRE</td> <td>7</td> <td>PZ</td> </tr> <tr> <td>VM1745A0</td> <td>CARD SUPPORT</td> <td>7</td> <td>PZ</td> </tr> <tr> <td>VM2147A0</td> <td>ESD SPONGE PINK SMOOTH 410X343X15 M</td> <td>1</td> <td>PZ</td> </tr> </tbody> </table>	Code	Description	Qty	UOM	PE1810B0	BAKERLUX POWER CARD	1	PZ	V11850A0	M4X6 NICKEL PLATED FIXING SCRE	7	PZ	VM1745A0	CARD SUPPORT	7	PZ	VM2147A0	ESD SPONGE PINK SMOOTH 410X343X15 M	1	PZ
Code	Description	Qty	UOM																						
PE1810B0	BAKERLUX POWER CARD	1	PZ																						
V11850A0	M4X6 NICKEL PLATED FIXING SCRE	7	PZ																						
VM1745A0	CARD SUPPORT	7	PZ																						
VM2147A0	ESD SPONGE PINK SMOOTH 410X343X15 M	1	PZ																						
VM2400A	LUX POWER BOARD PROTECTION		VM2400A0	LUX POWER BOARD PROTECTION																					



ASM2754B/0.D00 - General overview

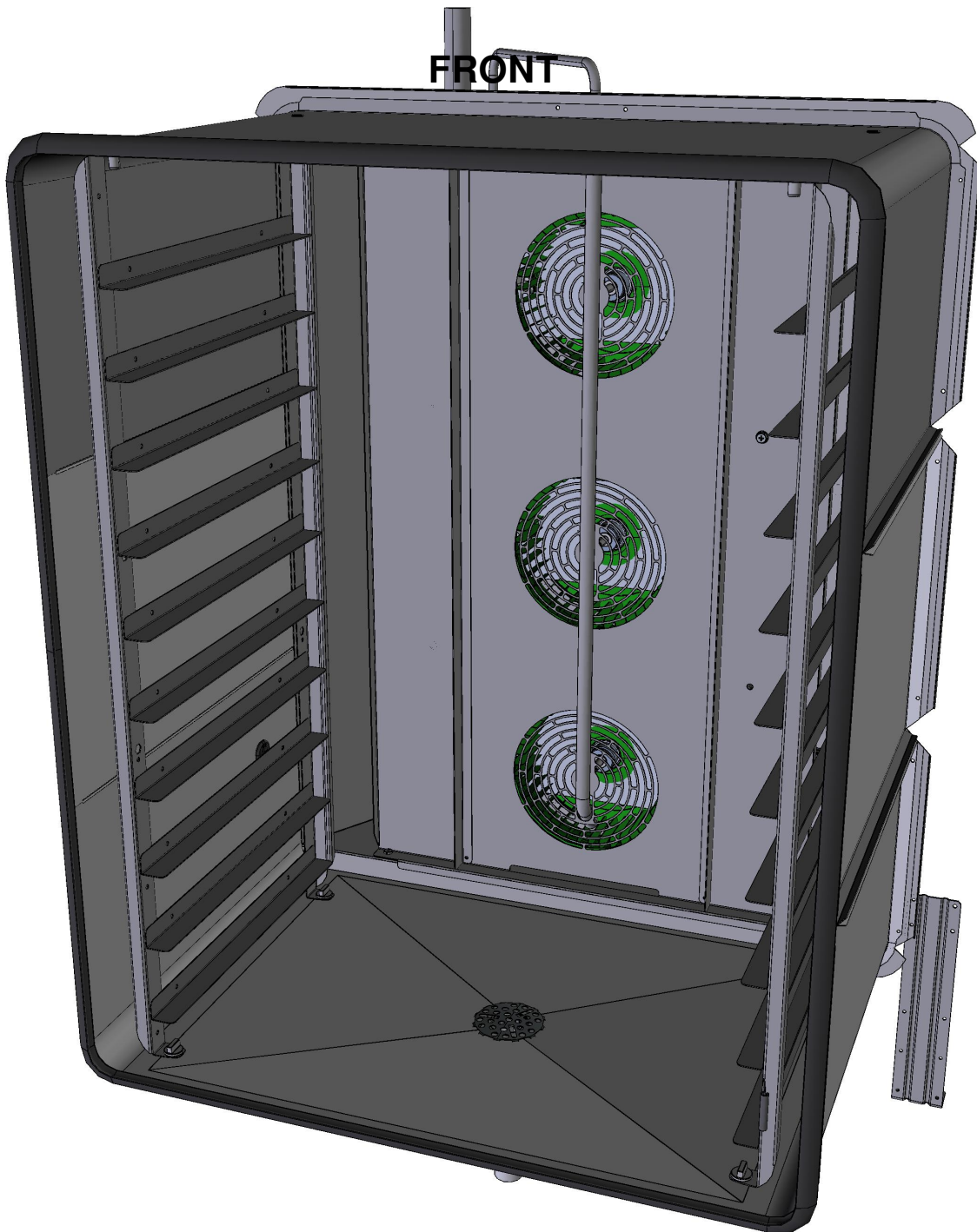



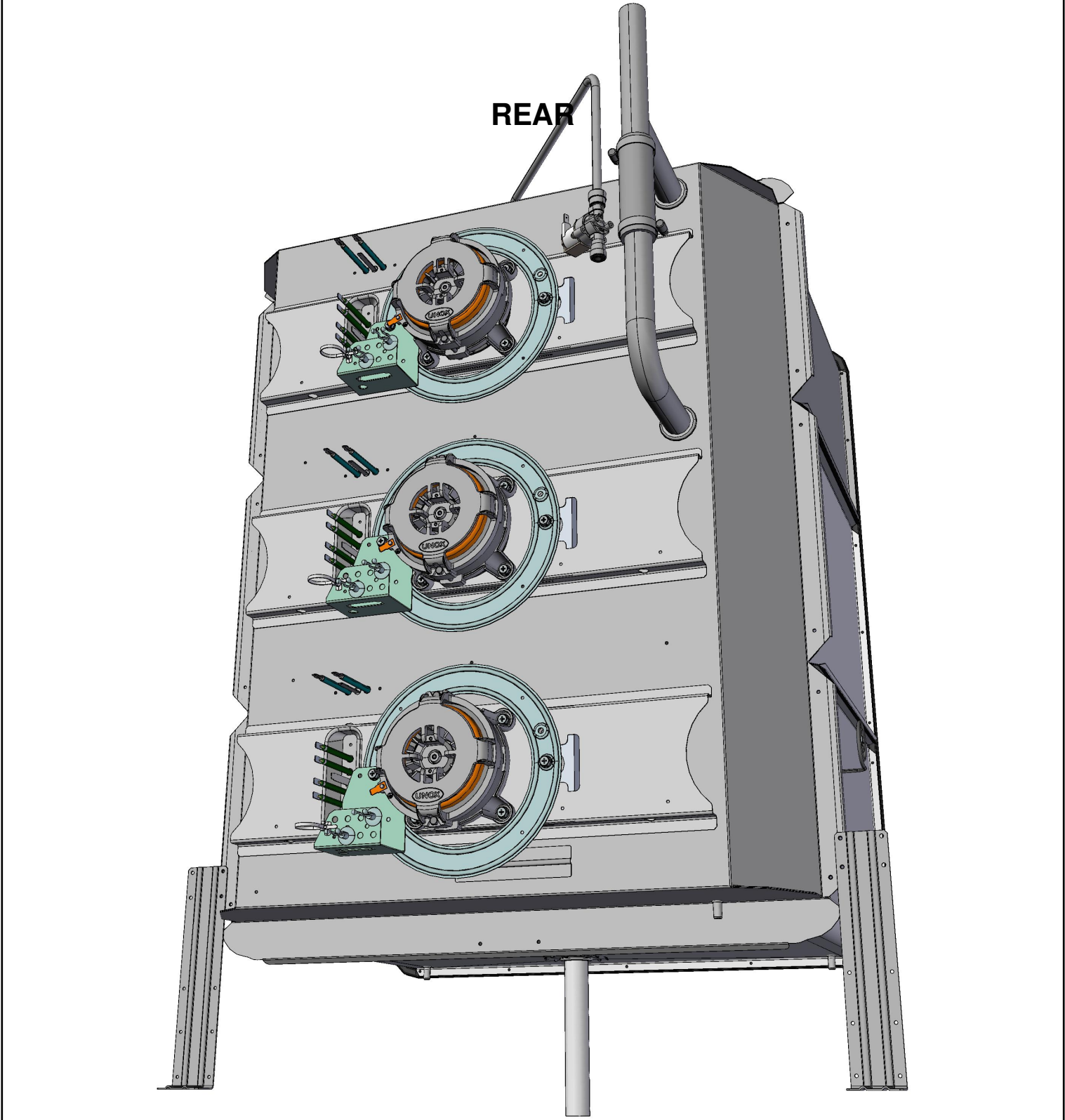

ASM2754B/0.D00 - General overview



COMPONENT			SPARE PART																										
Code	Description	Image	Code	Description	Components list																								
RC1170A	STAINLESS STEEL NUT M14 H=8 CH=22		KRC1170A	M14 H8 CH22 NUT - 10 PCS. KIT	<table border="1"> <thead> <tr> <th>Code</th> <th>Description</th> <th>Qty</th> <th>UOM</th> </tr> </thead> <tbody> <tr> <td>RC1170A1</td> <td>STAINLESS STEEL NUT M14 H=8 CH=2</td> <td>10</td> <td>PZ</td> </tr> </tbody> </table>	Code	Description	Qty	UOM	RC1170A1	STAINLESS STEEL NUT M14 H=8 CH=2	10	PZ																
Code	Description	Qty	UOM																										
RC1170A1	STAINLESS STEEL NUT M14 H=8 CH=2	10	PZ																										
0H4820A	BULB HOLDING BRACKET																												
GN1285A	NTC TEMPERATURE PROBE SEALING		KTR1106A	5-5E S. L2000 CHAMBER TEMP. PROBE KIT	<table border="1"> <thead> <tr> <th>Code</th> <th>Description</th> <th>Qty</th> <th>UOM</th> </tr> </thead> <tbody> <tr> <td>GN1285A0</td> <td>NTC TEMPERATUR E PROBE SEALING</td> <td>1</td> <td>PZ</td> </tr> <tr> <td>SL1045A0</td> <td>S53 BLACK SILICONE - 80ML CARTRIDGE</td> <td>1</td> <td>PZ</td> </tr> <tr> <td>TR1106A3</td> <td>PT100 L=2000 TEMPERATUR E PROBE</td> <td>1</td> <td>PZ</td> </tr> <tr> <td>VI1220A1</td> <td>4,2X12 TCB SELF-TAPPIN G SCREW</td> <td>2</td> <td>PZ</td> </tr> <tr> <td>VM1465A0</td> <td>CHEFTOP TEMPERATUR E PROBE COVER</td> <td>1</td> <td>PZ</td> </tr> </tbody> </table>	Code	Description	Qty	UOM	GN1285A0	NTC TEMPERATUR E PROBE SEALING	1	PZ	SL1045A0	S53 BLACK SILICONE - 80ML CARTRIDGE	1	PZ	TR1106A3	PT100 L=2000 TEMPERATUR E PROBE	1	PZ	VI1220A1	4,2X12 TCB SELF-TAPPIN G SCREW	2	PZ	VM1465A0	CHEFTOP TEMPERATUR E PROBE COVER	1	PZ
Code	Description	Qty	UOM																										
GN1285A0	NTC TEMPERATUR E PROBE SEALING	1	PZ																										
SL1045A0	S53 BLACK SILICONE - 80ML CARTRIDGE	1	PZ																										
TR1106A3	PT100 L=2000 TEMPERATUR E PROBE	1	PZ																										
VI1220A1	4,2X12 TCB SELF-TAPPIN G SCREW	2	PZ																										
VM1465A0	CHEFTOP TEMPERATUR E PROBE COVER	1	PZ																										
			KTR1105A	PT100 L1000 TEMPERATURE PROBE KIT	<table border="1"> <thead> <tr> <th>Code</th> <th>Description</th> <th>Qty</th> <th>UOM</th> </tr> </thead> <tbody> <tr> <td>GN1120A0</td> <td>TEMPERATUR E PROBE NTC SEAL</td> <td>1</td> <td>PZ</td> </tr> <tr> <td>GN1285A0</td> <td>NTC TEMPERATUR E PROBE SEALING</td> <td>1</td> <td>PZ</td> </tr> <tr> <td>SL1045A0</td> <td>S53 BLACK SILICONE - 80ML CARTRIDGE</td> <td>1</td> <td>PZ</td> </tr> <tr> <td>TR1105A3</td> <td>L=1000 PT1000 TEMPERATUR E PROBE</td> <td>1</td> <td>PZ</td> </tr> <tr> <td>TR1105A4</td> <td></td> <td>1</td> <td>PZ</td> </tr> </tbody> </table>	Code	Description	Qty	UOM	GN1120A0	TEMPERATUR E PROBE NTC SEAL	1	PZ	GN1285A0	NTC TEMPERATUR E PROBE SEALING	1	PZ	SL1045A0	S53 BLACK SILICONE - 80ML CARTRIDGE	1	PZ	TR1105A3	L=1000 PT1000 TEMPERATUR E PROBE	1	PZ	TR1105A4		1	PZ
Code	Description	Qty	UOM																										
GN1120A0	TEMPERATUR E PROBE NTC SEAL	1	PZ																										
GN1285A0	NTC TEMPERATUR E PROBE SEALING	1	PZ																										
SL1045A0	S53 BLACK SILICONE - 80ML CARTRIDGE	1	PZ																										
TR1105A3	L=1000 PT1000 TEMPERATUR E PROBE	1	PZ																										
TR1105A4		1	PZ																										

COMPONENT			SPARE PART																											
Code	Description	Image	Code	Description	Components list																									
GN1285A	NTC TEMPERATURE PROBE SEALING		KTR1105A	PT100 L1000 TEMPERATURE PROBE KIT	<table border="1"> <thead> <tr> <th>Code</th> <th>Description</th> <th>Qty</th> <th>UOM</th> </tr> </thead> <tbody> <tr> <td>VI1220A1</td> <td>4,2X12 TCB SELF-TAPPIN G SCREW</td> <td>2</td> <td>PZ</td> </tr> <tr> <td>VM1465A0</td> <td>CHEFTOP TEMPERATUR E PROBE COVER</td> <td>1</td> <td>PZ</td> </tr> </tbody> </table>	Code	Description	Qty	UOM	VI1220A1	4,2X12 TCB SELF-TAPPIN G SCREW	2	PZ	VM1465A0	CHEFTOP TEMPERATUR E PROBE COVER	1	PZ													
			Code	Description	Qty	UOM																								
			VI1220A1	4,2X12 TCB SELF-TAPPIN G SCREW	2	PZ																								
VM1465A0	CHEFTOP TEMPERATUR E PROBE COVER	1	PZ																											
KTR1096A	NTC 150 L=1500 TEMPERATURE PROBE KIT	<table border="1"> <thead> <tr> <th>Code</th> <th>Description</th> <th>Qty</th> <th>UOM</th> </tr> </thead> <tbody> <tr> <td>GN1120A0</td> <td>TEMPERATUR E PROBE NTC SEAL</td> <td>1</td> <td>PZ</td> </tr> <tr> <td>GN1285A0</td> <td>NTC TEMPERATUR E PROBE SEALING</td> <td>2</td> <td>PZ</td> </tr> <tr> <td>SL1045A0</td> <td>S53 BLACK SILICONE - 80ML CARTRIDGE</td> <td>1</td> <td>PZ</td> </tr> <tr> <td>TR1096A0</td> <td>TEMPERATUR E PROBE NTC 150 L=1500</td> <td>1</td> <td>PZ</td> </tr> <tr> <td>VI1220A1</td> <td>4,2X12 TCB SELF-TAPPIN G SCREW</td> <td>2</td> <td>PZ</td> </tr> <tr> <td>VM1465A0</td> <td>CHEFTOP TEMPERATUR E PROBE COVER</td> <td>1</td> <td>PZ</td> </tr> </tbody> </table>	Code	Description	Qty	UOM	GN1120A0	TEMPERATUR E PROBE NTC SEAL	1	PZ	GN1285A0	NTC TEMPERATUR E PROBE SEALING	2	PZ	SL1045A0	S53 BLACK SILICONE - 80ML CARTRIDGE	1	PZ	TR1096A0	TEMPERATUR E PROBE NTC 150 L=1500	1	PZ	VI1220A1	4,2X12 TCB SELF-TAPPIN G SCREW	2	PZ	VM1465A0	CHEFTOP TEMPERATUR E PROBE COVER	1	PZ
Code	Description	Qty	UOM																											
GN1120A0	TEMPERATUR E PROBE NTC SEAL	1	PZ																											
GN1285A0	NTC TEMPERATUR E PROBE SEALING	2	PZ																											
SL1045A0	S53 BLACK SILICONE - 80ML CARTRIDGE	1	PZ																											
TR1096A0	TEMPERATUR E PROBE NTC 150 L=1500	1	PZ																											
VI1220A1	4,2X12 TCB SELF-TAPPIN G SCREW	2	PZ																											
VM1465A0	CHEFTOP TEMPERATUR E PROBE COVER	1	PZ																											
KTR1095A	NTC 150 L=1050 TEMPERATURE PROBE KIT	<table border="1"> <thead> <tr> <th>Code</th> <th>Description</th> <th>Qty</th> <th>UOM</th> </tr> </thead> <tbody> <tr> <td>GN1120A0</td> <td>TEMPERATUR E PROBE NTC SEAL</td> <td>1</td> <td>PZ</td> </tr> <tr> <td>GN1285A0</td> <td>NTC TEMPERATUR E PROBE SEALING</td> <td>1</td> <td>PZ</td> </tr> <tr> <td>SL1045A0</td> <td>S53 BLACK SILICONE - 80ML CARTRIDGE</td> <td>1</td> <td>PZ</td> </tr> <tr> <td>TR1095A0</td> <td>TEMPERATUR E PROBE NTC 150 L=1050</td> <td>1</td> <td>PZ</td> </tr> <tr> <td>VI1220A1</td> <td>4,2X12 TCB SELF-TAPPIN G SCREW</td> <td>2</td> <td>PZ</td> </tr> <tr> <td>VM1465A0</td> <td>CHEFTOP TEMPERATUR E PROBE COVER</td> <td>1</td> <td>PZ</td> </tr> </tbody> </table>	Code	Description	Qty	UOM	GN1120A0	TEMPERATUR E PROBE NTC SEAL	1	PZ	GN1285A0	NTC TEMPERATUR E PROBE SEALING	1	PZ	SL1045A0	S53 BLACK SILICONE - 80ML CARTRIDGE	1	PZ	TR1095A0	TEMPERATUR E PROBE NTC 150 L=1050	1	PZ	VI1220A1	4,2X12 TCB SELF-TAPPIN G SCREW	2	PZ	VM1465A0	CHEFTOP TEMPERATUR E PROBE COVER	1	PZ
Code	Description	Qty	UOM																											
GN1120A0	TEMPERATUR E PROBE NTC SEAL	1	PZ																											
GN1285A0	NTC TEMPERATUR E PROBE SEALING	1	PZ																											
SL1045A0	S53 BLACK SILICONE - 80ML CARTRIDGE	1	PZ																											
TR1095A0	TEMPERATUR E PROBE NTC 150 L=1050	1	PZ																											
VI1220A1	4,2X12 TCB SELF-TAPPIN G SCREW	2	PZ																											
VM1465A0	CHEFTOP TEMPERATUR E PROBE COVER	1	PZ																											

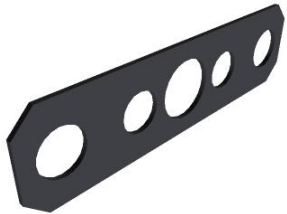

COMPONENT			SPARE PART																																		
Code	Description	Image	Code	Description	Components list																																
GN1285A	NTC TEMPERATURE PROBE SEALING		KTR1002A	PT100 L1000 UL TEMPERATURE PROBE KIT	<table border="1"> <thead> <tr> <th>Code</th> <th>Description</th> <th>Qty</th> <th>UOM</th> </tr> </thead> <tbody> <tr> <td>GN1285A0</td> <td>NTC TEMPERATUR E PROBE SEALING</td> <td>2</td> <td>PZ</td> </tr> <tr> <td>SL1045A0</td> <td>S53 BLACK SILICONE - 80ML CARTRIDGE</td> <td>1</td> <td>PZ</td> </tr> <tr> <td>TR1002A0</td> <td>TEMPERATUR E PROBE UL PT100 L1000</td> <td>1</td> <td>PZ</td> </tr> <tr> <td>TR1002A1</td> <td></td> <td>1</td> <td>PZ</td> </tr> <tr> <td>VI1220A1</td> <td>4,2X12 TCB SELF-TAPPIN G SCREW</td> <td>2</td> <td>PZ</td> </tr> <tr> <td>VM1465A0</td> <td>CHEFTOP TEMPERATUR E PROBE COVER</td> <td>1</td> <td>PZ</td> </tr> </tbody> </table>	Code	Description	Qty	UOM	GN1285A0	NTC TEMPERATUR E PROBE SEALING	2	PZ	SL1045A0	S53 BLACK SILICONE - 80ML CARTRIDGE	1	PZ	TR1002A0	TEMPERATUR E PROBE UL PT100 L1000	1	PZ	TR1002A1		1	PZ	VI1220A1	4,2X12 TCB SELF-TAPPIN G SCREW	2	PZ	VM1465A0	CHEFTOP TEMPERATUR E PROBE COVER	1	PZ				
Code	Description	Qty	UOM																																		
GN1285A0	NTC TEMPERATUR E PROBE SEALING	2	PZ																																		
SL1045A0	S53 BLACK SILICONE - 80ML CARTRIDGE	1	PZ																																		
TR1002A0	TEMPERATUR E PROBE UL PT100 L1000	1	PZ																																		
TR1002A1		1	PZ																																		
VI1220A1	4,2X12 TCB SELF-TAPPIN G SCREW	2	PZ																																		
VM1465A0	CHEFTOP TEMPERATUR E PROBE COVER	1	PZ																																		
VM1465A	CHEFTOP TEMPERATURE PROBE COVER		VM1465A0	CHEFTOP TEMPERATURE PROBE COVER																																	
TR1105A	L=1000 PT1000 TEMPERATURE PROBE		KTR1105A	PT100 L1000 TEMPERATURE PROBE KIT	<table border="1"> <thead> <tr> <th>Code</th> <th>Description</th> <th>Qty</th> <th>UOM</th> </tr> </thead> <tbody> <tr> <td>GN1120A0</td> <td>TEMPERATUR E PROBE NTC SEAL</td> <td>1</td> <td>PZ</td> </tr> <tr> <td>GN1285A0</td> <td>NTC TEMPERATUR E PROBE SEALING</td> <td>1</td> <td>PZ</td> </tr> <tr> <td>SL1045A0</td> <td>S53 BLACK SILICONE - 80ML CARTRIDGE</td> <td>1</td> <td>PZ</td> </tr> <tr> <td>TR1105A3</td> <td>L=1000 PT1000 TEMPERATUR E PROBE</td> <td>1</td> <td>PZ</td> </tr> <tr> <td>TR1105A4</td> <td></td> <td>1</td> <td>PZ</td> </tr> <tr> <td>VI1220A1</td> <td>4,2X12 TCB SELF-TAPPIN G SCREW</td> <td>2</td> <td>PZ</td> </tr> <tr> <td>VM1465A0</td> <td>CHEFTOP TEMPERATUR E PROBE COVER</td> <td>1</td> <td>PZ</td> </tr> </tbody> </table>	Code	Description	Qty	UOM	GN1120A0	TEMPERATUR E PROBE NTC SEAL	1	PZ	GN1285A0	NTC TEMPERATUR E PROBE SEALING	1	PZ	SL1045A0	S53 BLACK SILICONE - 80ML CARTRIDGE	1	PZ	TR1105A3	L=1000 PT1000 TEMPERATUR E PROBE	1	PZ	TR1105A4		1	PZ	VI1220A1	4,2X12 TCB SELF-TAPPIN G SCREW	2	PZ	VM1465A0	CHEFTOP TEMPERATUR E PROBE COVER	1	PZ
Code	Description	Qty	UOM																																		
GN1120A0	TEMPERATUR E PROBE NTC SEAL	1	PZ																																		
GN1285A0	NTC TEMPERATUR E PROBE SEALING	1	PZ																																		
SL1045A0	S53 BLACK SILICONE - 80ML CARTRIDGE	1	PZ																																		
TR1105A3	L=1000 PT1000 TEMPERATUR E PROBE	1	PZ																																		
TR1105A4		1	PZ																																		
VI1220A1	4,2X12 TCB SELF-TAPPIN G SCREW	2	PZ																																		
VM1465A0	CHEFTOP TEMPERATUR E PROBE COVER	1	PZ																																		

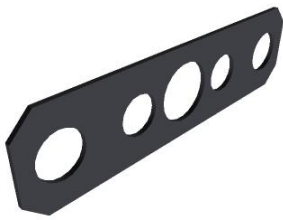
COMPONENT			SPARE PART																										
Code	Description	Image	Code	Description	Components list																								
0H2551A	XBC/XVC ST.STEEL DRAIN COVER		0H2551A0	XBC/XVC ST.STEEL DRAIN COVER																									
GN1326A	ELEMENT SEALING		KRS1261A	122W MOTOR BRAKING ELEMENT KIT	<table border="1"> <thead> <tr> <th>Code</th> <th>Description</th> <th>Qty</th> <th>UOM</th> </tr> </thead> <tbody> <tr> <td>GN1326A1</td> <td>ELEMENT SEALING</td> <td>1</td> <td>PZ</td> </tr> <tr> <td>RS1261A0</td> <td>BAKERLUX\CH EFLUX MOTOR BRAKING ELEMENT</td> <td>1</td> <td>PZ</td> </tr> <tr> <td>SL1045A0</td> <td>S53 BLACK SILICONE - 80ML CARTRIDGE</td> <td>1</td> <td>PZ</td> </tr> <tr> <td>VI1220A1</td> <td>4,2X12 TCB SELF-TAPPIN G SCREW</td> <td>2</td> <td>PZ</td> </tr> <tr> <td>VM2147A0</td> <td>ESD SPONGE PINK SMOOTH 410X343X15 M</td> <td>1</td> <td>PZ</td> </tr> </tbody> </table>	Code	Description	Qty	UOM	GN1326A1	ELEMENT SEALING	1	PZ	RS1261A0	BAKERLUX\CH EFLUX MOTOR BRAKING ELEMENT	1	PZ	SL1045A0	S53 BLACK SILICONE - 80ML CARTRIDGE	1	PZ	VI1220A1	4,2X12 TCB SELF-TAPPIN G SCREW	2	PZ	VM2147A0	ESD SPONGE PINK SMOOTH 410X343X15 M	1	PZ
Code	Description	Qty	UOM																										
GN1326A1	ELEMENT SEALING	1	PZ																										
RS1261A0	BAKERLUX\CH EFLUX MOTOR BRAKING ELEMENT	1	PZ																										
SL1045A0	S53 BLACK SILICONE - 80ML CARTRIDGE	1	PZ																										
VI1220A1	4,2X12 TCB SELF-TAPPIN G SCREW	2	PZ																										
VM2147A0	ESD SPONGE PINK SMOOTH 410X343X15 M	1	PZ																										
			KRS1215A	147W MOTOR BRAKING ELEMENT KIT	<table border="1"> <thead> <tr> <th>Code</th> <th>Description</th> <th>Qty</th> <th>UOM</th> </tr> </thead> <tbody> <tr> <td>GN1326A1</td> <td>ELEMENT SEALING</td> <td>1</td> <td>PZ</td> </tr> <tr> <td>RS1215A1</td> <td>147W 105V BRAKING ELEMENT</td> <td>1</td> <td>PZ</td> </tr> <tr> <td>SL1045A0</td> <td>S53 BLACK SILICONE - 80ML CARTRIDGE</td> <td>1</td> <td>PZ</td> </tr> <tr> <td>VI1220A1</td> <td>4,2X12 TCB SELF-TAPPIN G SCREW</td> <td>2</td> <td>PZ</td> </tr> <tr> <td>VM2147A0</td> <td>ESD SPONGE PINK SMOOTH 410X343X15 M</td> <td>1</td> <td>PZ</td> </tr> </tbody> </table>	Code	Description	Qty	UOM	GN1326A1	ELEMENT SEALING	1	PZ	RS1215A1	147W 105V BRAKING ELEMENT	1	PZ	SL1045A0	S53 BLACK SILICONE - 80ML CARTRIDGE	1	PZ	VI1220A1	4,2X12 TCB SELF-TAPPIN G SCREW	2	PZ	VM2147A0	ESD SPONGE PINK SMOOTH 410X343X15 M	1	PZ
Code	Description	Qty	UOM																										
GN1326A1	ELEMENT SEALING	1	PZ																										
RS1215A1	147W 105V BRAKING ELEMENT	1	PZ																										
SL1045A0	S53 BLACK SILICONE - 80ML CARTRIDGE	1	PZ																										
VI1220A1	4,2X12 TCB SELF-TAPPIN G SCREW	2	PZ																										
VM2147A0	ESD SPONGE PINK SMOOTH 410X343X15 M	1	PZ																										
			KRS1095A	1.2KW HEATING ELEMENT KIT	<table border="1"> <thead> <tr> <th>Code</th> <th>Description</th> <th>Qty</th> <th>UOM</th> </tr> </thead> <tbody> <tr> <td>GN1326A1</td> <td>ELEMENT SEALING</td> <td>1</td> <td>PZ</td> </tr> <tr> <td>IP1385A0</td> <td>CORNER POLYSTYREN E PACKING 110X80X2000</td> <td>1.200</td> <td>PZ</td> </tr> <tr> <td>IP1385A1</td> <td>CORNER POLYSTYREN E PACKING 110X80X2000</td> <td>0.500</td> <td>M</td> </tr> </tbody> </table>	Code	Description	Qty	UOM	GN1326A1	ELEMENT SEALING	1	PZ	IP1385A0	CORNER POLYSTYREN E PACKING 110X80X2000	1.200	PZ	IP1385A1	CORNER POLYSTYREN E PACKING 110X80X2000	0.500	M								
Code	Description	Qty	UOM																										
GN1326A1	ELEMENT SEALING	1	PZ																										
IP1385A0	CORNER POLYSTYREN E PACKING 110X80X2000	1.200	PZ																										
IP1385A1	CORNER POLYSTYREN E PACKING 110X80X2000	0.500	M																										

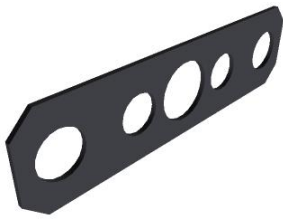



COMPONENT			SPARE PART																											
Code	Description	Image	Code	Description	Components list																									
GN1326A	ELEMENT SEALING		KRS1095A	1.2KW HEATING ELEMENT KIT	<table border="1"> <thead> <tr> <th>Code</th> <th>Description</th> <th>Qty</th> <th>UOM</th> </tr> </thead> <tbody> <tr> <td>RS1095A1</td> <td>HEATING ELEMENT 1200W 230V</td> <td>1</td> <td>PZ</td> </tr> <tr> <td>SL1045A0</td> <td>S53 BLACK SILICONE - 80ML CARTRIDGE</td> <td>1</td> <td>PZ</td> </tr> <tr> <td>VI1220A1</td> <td>4,2X12 TCB SELF-TAPPIN G SCREW</td> <td>2</td> <td>PZ</td> </tr> <tr> <td>VM1059A1</td> <td>HEAT SHRINK FILM H800</td> <td>1.200</td> <td>M</td> </tr> </tbody> </table>	Code	Description	Qty	UOM	RS1095A1	HEATING ELEMENT 1200W 230V	1	PZ	SL1045A0	S53 BLACK SILICONE - 80ML CARTRIDGE	1	PZ	VI1220A1	4,2X12 TCB SELF-TAPPIN G SCREW	2	PZ	VM1059A1	HEAT SHRINK FILM H800	1.200	M					
			Code	Description	Qty	UOM																								
			RS1095A1	HEATING ELEMENT 1200W 230V	1	PZ																								
			SL1045A0	S53 BLACK SILICONE - 80ML CARTRIDGE	1	PZ																								
			VI1220A1	4,2X12 TCB SELF-TAPPIN G SCREW	2	PZ																								
			VM1059A1	HEAT SHRINK FILM H800	1.200	M																								
			KRS1012A	1365W 120V HEATING ELEMENT KIT	<table border="1"> <thead> <tr> <th>Code</th> <th>Description</th> <th>Qty</th> <th>UOM</th> </tr> </thead> <tbody> <tr> <td>GN1326A1</td> <td>ELEMENT SEALING</td> <td>1</td> <td>PZ</td> </tr> <tr> <td>RS1012A0</td> <td>CIRCULAR ELEMENT 1365W 120V</td> <td>1</td> <td>PZ</td> </tr> <tr> <td>VI1220A1</td> <td>4,2X12 TCB SELF-TAPPIN G SCREW</td> <td>5</td> <td>PZ</td> </tr> <tr> <td>VM1794A0</td> <td>250X4.8 PA66 BLACK CLAMP</td> <td>2</td> <td>PZ</td> </tr> <tr> <td>VM2103A0</td> <td>CLAMP LOCK</td> <td>2</td> <td>PZ</td> </tr> </tbody> </table>	Code	Description	Qty	UOM	GN1326A1	ELEMENT SEALING	1	PZ	RS1012A0	CIRCULAR ELEMENT 1365W 120V	1	PZ	VI1220A1	4,2X12 TCB SELF-TAPPIN G SCREW	5	PZ	VM1794A0	250X4.8 PA66 BLACK CLAMP	2	PZ	VM2103A0	CLAMP LOCK	2	PZ	
			Code	Description	Qty	UOM																								
			GN1326A1	ELEMENT SEALING	1	PZ																								
			RS1012A0	CIRCULAR ELEMENT 1365W 120V	1	PZ																								
			VI1220A1	4,2X12 TCB SELF-TAPPIN G SCREW	5	PZ																								
			VM1794A0	250X4.8 PA66 BLACK CLAMP	2	PZ																								
VM2103A0	CLAMP LOCK	2	PZ																											
KRS1011A	ROBERTA/LISA HEATING ELEMENT KIT	<table border="1"> <thead> <tr> <th>Code</th> <th>Description</th> <th>Qty</th> <th>UOM</th> </tr> </thead> <tbody> <tr> <td>GN1326A1</td> <td>ELEMENT SEALING</td> <td>1</td> <td>PZ</td> </tr> <tr> <td>RS1011A0</td> <td>2560W HEATING ELEMENT</td> <td>1</td> <td>PZ</td> </tr> <tr> <td>SL1045A0</td> <td>S53 BLACK SILICONE - 80ML CARTRIDGE</td> <td>1</td> <td>PZ</td> </tr> <tr> <td>VI1220A1</td> <td>4,2X12 TCB SELF-TAPPIN G SCREW</td> <td>5</td> <td>PZ</td> </tr> <tr> <td>VM1794A0</td> <td>250X4.8 PA66 BLACK CLAMP</td> <td>2</td> <td>PZ</td> </tr> <tr> <td>VM2103A0</td> <td>CLAMP LOCK</td> <td>2</td> <td>PZ</td> </tr> </tbody> </table>	Code	Description	Qty	UOM	GN1326A1	ELEMENT SEALING	1	PZ	RS1011A0	2560W HEATING ELEMENT	1	PZ	SL1045A0	S53 BLACK SILICONE - 80ML CARTRIDGE	1	PZ	VI1220A1	4,2X12 TCB SELF-TAPPIN G SCREW	5	PZ	VM1794A0	250X4.8 PA66 BLACK CLAMP	2	PZ	VM2103A0	CLAMP LOCK	2	PZ
Code	Description	Qty	UOM																											
GN1326A1	ELEMENT SEALING	1	PZ																											
RS1011A0	2560W HEATING ELEMENT	1	PZ																											
SL1045A0	S53 BLACK SILICONE - 80ML CARTRIDGE	1	PZ																											
VI1220A1	4,2X12 TCB SELF-TAPPIN G SCREW	5	PZ																											
VM1794A0	250X4.8 PA66 BLACK CLAMP	2	PZ																											
VM2103A0	CLAMP LOCK	2	PZ																											
KRS0090A	HEATING ELEMENT 1.26KW	<table border="1"> <thead> <tr> <th>Code</th> <th>Description</th> <th>Qty</th> <th>UOM</th> </tr> </thead> <tbody> <tr> <td>GN1326A1</td> <td>ELEMENT SEALING</td> <td>1</td> <td>PZ</td> </tr> <tr> <td>RS0090A0</td> <td>CIRC. HEAT. ELEMENT 1260W 220-230</td> <td>1</td> <td>PZ</td> </tr> <tr> <td>VI1220A1</td> <td>4,2X12 TCB SELF-TAPPIN G SCREW</td> <td>3</td> <td>PZ</td> </tr> </tbody> </table>	Code	Description	Qty	UOM	GN1326A1	ELEMENT SEALING	1	PZ	RS0090A0	CIRC. HEAT. ELEMENT 1260W 220-230	1	PZ	VI1220A1	4,2X12 TCB SELF-TAPPIN G SCREW	3	PZ												
Code	Description	Qty	UOM																											
GN1326A1	ELEMENT SEALING	1	PZ																											
RS0090A0	CIRC. HEAT. ELEMENT 1260W 220-230	1	PZ																											
VI1220A1	4,2X12 TCB SELF-TAPPIN G SCREW	3	PZ																											



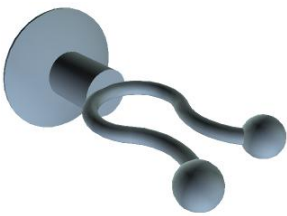
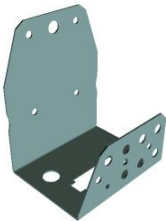

COMPONENT			SPARE PART																							
Code	Description	Image	Code	Description	Components list																					
GN1326A	ELEMENT SEALING		KRS0090A	HEATING ELEMENT 1.26KW	<table border="1"> <thead> <tr> <th>Code</th> <th>Description</th> <th>Qty</th> <th>UOM</th> </tr> </thead> <tbody> <tr> <td>VM1794A0</td> <td>250X4.8 PA66 BLACK CLAMP</td> <td>2</td> <td>PZ</td> </tr> <tr> <td>VM2103A0</td> <td>CLAMP LOCK</td> <td>2</td> <td>PZ</td> </tr> </tbody> </table>	Code	Description	Qty	UOM	VM1794A0	250X4.8 PA66 BLACK CLAMP	2	PZ	VM2103A0	CLAMP LOCK	2	PZ									
			Code	Description	Qty	UOM																				
			VM1794A0	250X4.8 PA66 BLACK CLAMP	2	PZ																				
			VM2103A0	CLAMP LOCK	2	PZ																				
KRS0050A	HEATING ELEMENT KIT 0.5KW	<table border="1"> <thead> <tr> <th>Code</th> <th>Description</th> <th>Qty</th> <th>UOM</th> </tr> </thead> <tbody> <tr> <td>GN1326A1</td> <td>ELEMENT SEALING</td> <td>1</td> <td>PZ</td> </tr> <tr> <td>IP1075A1</td> <td></td> <td>1</td> <td>PZ</td> </tr> <tr> <td>IP1080A1</td> <td></td> <td>1</td> <td>PZ</td> </tr> <tr> <td>RS0050A0</td> <td>HEAT. ELEMENT 500W 220-230V LIEV</td> <td>1</td> <td>PZ</td> </tr> <tr> <td>VI1220A1</td> <td>4,2X12 TCB SELF-TAPPIN G SCREW</td> <td>2</td> <td>PZ</td> </tr> </tbody> </table>	Code	Description	Qty	UOM	GN1326A1	ELEMENT SEALING	1	PZ	IP1075A1		1	PZ	IP1080A1		1	PZ	RS0050A0	HEAT. ELEMENT 500W 220-230V LIEV	1	PZ	VI1220A1	4,2X12 TCB SELF-TAPPIN G SCREW	2	PZ
Code	Description	Qty	UOM																							
GN1326A1	ELEMENT SEALING	1	PZ																							
IP1075A1		1	PZ																							
IP1080A1		1	PZ																							
RS0050A0	HEAT. ELEMENT 500W 220-230V LIEV	1	PZ																							
VI1220A1	4,2X12 TCB SELF-TAPPIN G SCREW	2	PZ																							
KRS0011A	HEATING ELEMENT 1.465KW RS0011A	<table border="1"> <thead> <tr> <th>Code</th> <th>Description</th> <th>Qty</th> <th>UOM</th> </tr> </thead> <tbody> <tr> <td>GN1326A1</td> <td>ELEMENT SEALING</td> <td>1</td> <td>PZ</td> </tr> <tr> <td>RS0011A0</td> <td>CIRC.HEAT. ELEMENT 1465W 220-230</td> <td>1</td> <td>PZ</td> </tr> <tr> <td>VI1220A1</td> <td>4,2X12 TCB SELF-TAPPIN G SCREW</td> <td>3</td> <td>PZ</td> </tr> <tr> <td>VM1794A0</td> <td>250X4.8 PA66 BLACK CLAMP</td> <td>2</td> <td>PZ</td> </tr> <tr> <td>VM2103A0</td> <td>CLAMP LOCK</td> <td>2</td> <td>PZ</td> </tr> </tbody> </table>	Code	Description	Qty	UOM	GN1326A1	ELEMENT SEALING	1	PZ	RS0011A0	CIRC.HEAT. ELEMENT 1465W 220-230	1	PZ	VI1220A1	4,2X12 TCB SELF-TAPPIN G SCREW	3	PZ	VM1794A0	250X4.8 PA66 BLACK CLAMP	2	PZ	VM2103A0	CLAMP LOCK	2	PZ
Code	Description	Qty	UOM																							
GN1326A1	ELEMENT SEALING	1	PZ																							
RS0011A0	CIRC.HEAT. ELEMENT 1465W 220-230	1	PZ																							
VI1220A1	4,2X12 TCB SELF-TAPPIN G SCREW	3	PZ																							
VM1794A0	250X4.8 PA66 BLACK CLAMP	2	PZ																							
VM2103A0	CLAMP LOCK	2	PZ																							
KRS0010A	KIT HEATING ELEMENT RS10010A	<table border="1"> <thead> <tr> <th>Code</th> <th>Description</th> <th>Qty</th> <th>UOM</th> </tr> </thead> <tbody> <tr> <td>GN1326A1</td> <td>ELEMENT SEALING</td> <td>1</td> <td>PZ</td> </tr> <tr> <td>IP1075A1</td> <td></td> <td>1</td> <td>PZ</td> </tr> <tr> <td>IP1080A1</td> <td></td> <td>5</td> <td>PZ</td> </tr> <tr> <td>RS0010A0</td> <td>CIRC.HEAT. ELEMENT 2560W - 220-230 V</td> <td>1</td> <td>PZ</td> </tr> <tr> <td>VI1220A1</td> <td>4,2X12 TCB SELF-TAPPIN G SCREW</td> <td>3</td> <td>PZ</td> </tr> </tbody> </table>	Code	Description	Qty	UOM	GN1326A1	ELEMENT SEALING	1	PZ	IP1075A1		1	PZ	IP1080A1		5	PZ	RS0010A0	CIRC.HEAT. ELEMENT 2560W - 220-230 V	1	PZ	VI1220A1	4,2X12 TCB SELF-TAPPIN G SCREW	3	PZ
Code	Description	Qty	UOM																							
GN1326A1	ELEMENT SEALING	1	PZ																							
IP1075A1		1	PZ																							
IP1080A1		5	PZ																							
RS0010A0	CIRC.HEAT. ELEMENT 2560W - 220-230 V	1	PZ																							
VI1220A1	4,2X12 TCB SELF-TAPPIN G SCREW	3	PZ																							
KG1326A	HEATING ELEMENT GASKET 5 PCS KIT	<table border="1"> <thead> <tr> <th>Code</th> <th>Description</th> <th>Qty</th> <th>UOM</th> </tr> </thead> <tbody> <tr> <td>GN1326A1</td> <td>ELEMENT SEALING</td> <td>5</td> <td>PZ</td> </tr> </tbody> </table>	Code	Description	Qty	UOM	GN1326A1	ELEMENT SEALING	5	PZ																
Code	Description	Qty	UOM																							
GN1326A1	ELEMENT SEALING	5	PZ																							



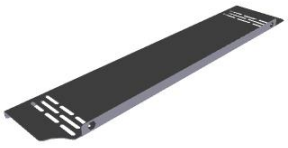

COMPONENT			SPARE PART																														
Code	Description	Image	Code	Description	Components list																												
EL1252A	1 WAY WATER VALVE + J.G. CONNECTION		KEL1252A	EL2 JG D8-D10 1 WAY SOLENOID VALVE KIT	<table border="1"> <thead> <tr> <th>Code</th> <th>Description</th> <th>Qty</th> <th>UOM</th> </tr> </thead> <tbody> <tr> <td>EL1252A1</td> <td>1 WAY WATER VALVE + J.G. CONNECTION</td> <td>1</td> <td>PZ</td> </tr> </tbody> </table>	Code	Description	Qty	UOM	EL1252A1	1 WAY WATER VALVE + J.G. CONNECTION	1	PZ																				
Code	Description	Qty	UOM																														
EL1252A1	1 WAY WATER VALVE + J.G. CONNECTION	1	PZ																														
RC1055A	Ø25-40 H12 STAINLESS STEEL PIPE CLIP		KRC1055A	Ø25-40 H12 ST.STEEL PIPE CLAMP 10PCS KIT	<table border="1"> <thead> <tr> <th>Code</th> <th>Description</th> <th>Qty</th> <th>UOM</th> </tr> </thead> <tbody> <tr> <td>RC1055A0</td> <td>Ø25-40 H12 STAINLESS STEEL PIPE CLIP</td> <td>10</td> <td>PZ</td> </tr> </tbody> </table>	Code	Description	Qty	UOM	RC1055A0	Ø25-40 H12 STAINLESS STEEL PIPE CLIP	10	PZ																				
Code	Description	Qty	UOM																														
RC1055A0	Ø25-40 H12 STAINLESS STEEL PIPE CLIP	10	PZ																														
RS1150A	4,9KW HEATING ELEMENT		KRS1150A	4.9KW HEATING ELEMENT KIT	<table border="1"> <thead> <tr> <th>Code</th> <th>Description</th> <th>Qty</th> <th>UOM</th> </tr> </thead> <tbody> <tr> <td>GN1327A0</td> <td>HEATING ELEMENT GASKET</td> <td>1</td> <td>PZ</td> </tr> <tr> <td>RS1150A0</td> <td>4,9KW HEATING ELEMENT</td> <td>1</td> <td>PZ</td> </tr> <tr> <td>SL1045A0</td> <td>S53 BLACK SILICONE - 80ML CARTRIDGE</td> <td>1</td> <td>PZ</td> </tr> <tr> <td>VI1220A1</td> <td>4,2X12 TCB SELF-TAPPING SCREW</td> <td>5</td> <td>PZ</td> </tr> <tr> <td>VM1794A0</td> <td>250X4.8 PA66 BLACK CLAMP</td> <td>2</td> <td>PZ</td> </tr> <tr> <td>VM2103A0</td> <td>CLAMP LOCK</td> <td>2</td> <td>PZ</td> </tr> </tbody> </table>	Code	Description	Qty	UOM	GN1327A0	HEATING ELEMENT GASKET	1	PZ	RS1150A0	4,9KW HEATING ELEMENT	1	PZ	SL1045A0	S53 BLACK SILICONE - 80ML CARTRIDGE	1	PZ	VI1220A1	4,2X12 TCB SELF-TAPPING SCREW	5	PZ	VM1794A0	250X4.8 PA66 BLACK CLAMP	2	PZ	VM2103A0	CLAMP LOCK	2	PZ
Code	Description	Qty	UOM																														
GN1327A0	HEATING ELEMENT GASKET	1	PZ																														
RS1150A0	4,9KW HEATING ELEMENT	1	PZ																														
SL1045A0	S53 BLACK SILICONE - 80ML CARTRIDGE	1	PZ																														
VI1220A1	4,2X12 TCB SELF-TAPPING SCREW	5	PZ																														
VM1794A0	250X4.8 PA66 BLACK CLAMP	2	PZ																														
VM2103A0	CLAMP LOCK	2	PZ																														
GN1140A	MOTOR HOLDER GASKET		KG1140A	5 PCS. MOTOR SUPP. GASKET KIT	<table border="1"> <thead> <tr> <th>Code</th> <th>Description</th> <th>Qty</th> <th>UOM</th> </tr> </thead> <tbody> <tr> <td>GN1140A2</td> <td>MOTOR HOLDER GASKET</td> <td>5</td> <td>PZ</td> </tr> </tbody> </table>	Code	Description	Qty	UOM	GN1140A2	MOTOR HOLDER GASKET	5	PZ																				
Code	Description	Qty	UOM																														
GN1140A2	MOTOR HOLDER GASKET	5	PZ																														

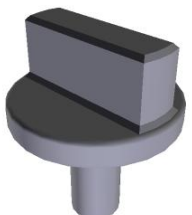
COMPONENT			SPARE PART																																						
Code	Description	Image	Code	Description	Components list																																				
0H4305A	ST. STEEL MOTOR SHAFT SEALING DIS		K0H4305A	SEALING DISC FOR MOTOR SHAFT KIT	<table border="1"> <thead> <tr> <th>Code</th> <th>Description</th> <th>Qty</th> <th>UOM</th> </tr> </thead> <tbody> <tr> <td>0H4305A1</td> <td>ST. STEEL MOTOR SHAFT SEALING DISC</td> <td>1</td> <td>PZ</td> </tr> <tr> <td>GN1140A2</td> <td>MOTOR HOLDER GASKET</td> <td>1</td> <td>PZ</td> </tr> <tr> <td>SL1045A0</td> <td>S53 BLACK SILICONE - 80ML CARTRIDGE</td> <td>1</td> <td>PZ</td> </tr> <tr> <td>VI1220A1</td> <td>4,2X12 TCB SELF-TAPPIN G SCREW</td> <td>3</td> <td>PZ</td> </tr> </tbody> </table>	Code	Description	Qty	UOM	0H4305A1	ST. STEEL MOTOR SHAFT SEALING DISC	1	PZ	GN1140A2	MOTOR HOLDER GASKET	1	PZ	SL1045A0	S53 BLACK SILICONE - 80ML CARTRIDGE	1	PZ	VI1220A1	4,2X12 TCB SELF-TAPPIN G SCREW	3	PZ																
					Code	Description	Qty	UOM																																	
					0H4305A1	ST. STEEL MOTOR SHAFT SEALING DISC	1	PZ																																	
					GN1140A2	MOTOR HOLDER GASKET	1	PZ																																	
SL1045A0	S53 BLACK SILICONE - 80ML CARTRIDGE	1	PZ																																						
VI1220A1	4,2X12 TCB SELF-TAPPIN G SCREW	3	PZ																																						
<table border="1"> <thead> <tr> <th>Code</th> <th>Description</th> <th>Qty</th> <th>UOM</th> </tr> </thead> <tbody> <tr> <td>GN1140A2</td> <td>MOTOR HOLDER GASKET</td> <td>1</td> <td>PZ</td> </tr> </tbody> </table>	Code	Description	Qty	UOM	GN1140A2	MOTOR HOLDER GASKET	1	PZ																																	
Code	Description	Qty	UOM																																						
GN1140A2	MOTOR HOLDER GASKET	1	PZ																																						
<table border="1"> <thead> <tr> <th>Code</th> <th>Description</th> <th>Qty</th> <th>UOM</th> </tr> </thead> <tbody> <tr> <td>SL1045A0</td> <td>S53 BLACK SILICONE - 80ML CARTRIDGE</td> <td>1</td> <td>PZ</td> </tr> </tbody> </table>	Code	Description	Qty	UOM	SL1045A0	S53 BLACK SILICONE - 80ML CARTRIDGE	1	PZ																																	
Code	Description	Qty	UOM																																						
SL1045A0	S53 BLACK SILICONE - 80ML CARTRIDGE	1	PZ																																						
<table border="1"> <thead> <tr> <th>Code</th> <th>Description</th> <th>Qty</th> <th>UOM</th> </tr> </thead> <tbody> <tr> <td>VI1220A1</td> <td>4,2X12 TCB SELF-TAPPIN G SCREW</td> <td>3</td> <td>PZ</td> </tr> </tbody> </table>	Code	Description	Qty	UOM	VI1220A1	4,2X12 TCB SELF-TAPPIN G SCREW	3	PZ																																	
Code	Description	Qty	UOM																																						
VI1220A1	4,2X12 TCB SELF-TAPPIN G SCREW	3	PZ																																						
VN1130A	330W 230V 50/60HZ MOTOR		KVN1130A	330W 230V 50/60HZ MOTOR KIT	<table border="1"> <thead> <tr> <th>Code</th> <th>Description</th> <th>Qty</th> <th>UOM</th> </tr> </thead> <tbody> <tr> <td>GN1140A2</td> <td>MOTOR HOLDER GASKET</td> <td>1</td> <td>PZ</td> </tr> <tr> <td>VI1045A0</td> <td>16X8,4 TH=1,6 ST.STEEL WASHER</td> <td>1</td> <td>PZ</td> </tr> <tr> <td>VI1255A0</td> <td>M8 H=8 BRASS-CHRO MED NUT</td> <td>2</td> <td>PZ</td> </tr> <tr> <td>VI1256A0</td> <td>M8 DIN 980M ST. STEEL SELF LOCKING NUT</td> <td>1</td> <td>PZ</td> </tr> <tr> <td>VM1794A0</td> <td>250X4.8 PA66 BLACK CLAMP</td> <td>4</td> <td>PZ</td> </tr> <tr> <td>VM2103A0</td> <td>CLAMP LOCK</td> <td>4</td> <td>PZ</td> </tr> <tr> <td>VM2196A0</td> <td>MOTOR NUT FIXING BUSHING</td> <td>1</td> <td>PZ</td> </tr> <tr> <td>VN1130A1</td> <td>330W 230V 50/60HZ MOTO</td> <td>1</td> <td>PZ</td> </tr> </tbody> </table>	Code	Description	Qty	UOM	GN1140A2	MOTOR HOLDER GASKET	1	PZ	VI1045A0	16X8,4 TH=1,6 ST.STEEL WASHER	1	PZ	VI1255A0	M8 H=8 BRASS-CHRO MED NUT	2	PZ	VI1256A0	M8 DIN 980M ST. STEEL SELF LOCKING NUT	1	PZ	VM1794A0	250X4.8 PA66 BLACK CLAMP	4	PZ	VM2103A0	CLAMP LOCK	4	PZ	VM2196A0	MOTOR NUT FIXING BUSHING	1	PZ	VN1130A1	330W 230V 50/60HZ MOTO	1	PZ
					Code	Description	Qty	UOM																																	
					GN1140A2	MOTOR HOLDER GASKET	1	PZ																																	
					VI1045A0	16X8,4 TH=1,6 ST.STEEL WASHER	1	PZ																																	
					VI1255A0	M8 H=8 BRASS-CHRO MED NUT	2	PZ																																	
					VI1256A0	M8 DIN 980M ST. STEEL SELF LOCKING NUT	1	PZ																																	
					VM1794A0	250X4.8 PA66 BLACK CLAMP	4	PZ																																	
					VM2103A0	CLAMP LOCK	4	PZ																																	
					VM2196A0	MOTOR NUT FIXING BUSHING	1	PZ																																	
					VN1130A1	330W 230V 50/60HZ MOTO	1	PZ																																	
<table border="1"> <thead> <tr> <th>Code</th> <th>Description</th> <th>Qty</th> <th>UOM</th> </tr> </thead> <tbody> <tr> <td>GN1140A2</td> <td>MOTOR HOLDER GASKET</td> <td>1</td> <td>PZ</td> </tr> </tbody> </table>	Code	Description	Qty	UOM	GN1140A2	MOTOR HOLDER GASKET	1	PZ																																	
Code	Description	Qty	UOM																																						
GN1140A2	MOTOR HOLDER GASKET	1	PZ																																						
<table border="1"> <thead> <tr> <th>Code</th> <th>Description</th> <th>Qty</th> <th>UOM</th> </tr> </thead> <tbody> <tr> <td>VI1045A0</td> <td>16X8,4 TH=1,6 ST.STEEL WASHER</td> <td>1</td> <td>PZ</td> </tr> </tbody> </table>	Code	Description	Qty	UOM	VI1045A0	16X8,4 TH=1,6 ST.STEEL WASHER	1	PZ																																	
Code	Description	Qty	UOM																																						
VI1045A0	16X8,4 TH=1,6 ST.STEEL WASHER	1	PZ																																						
<table border="1"> <thead> <tr> <th>Code</th> <th>Description</th> <th>Qty</th> <th>UOM</th> </tr> </thead> <tbody> <tr> <td>VI1255A0</td> <td>M8 H=8 BRASS-CHRO MED NUT</td> <td>2</td> <td>PZ</td> </tr> </tbody> </table>	Code	Description	Qty	UOM	VI1255A0	M8 H=8 BRASS-CHRO MED NUT	2	PZ																																	
Code	Description	Qty	UOM																																						
VI1255A0	M8 H=8 BRASS-CHRO MED NUT	2	PZ																																						
<table border="1"> <thead> <tr> <th>Code</th> <th>Description</th> <th>Qty</th> <th>UOM</th> </tr> </thead> <tbody> <tr> <td>VI1256A0</td> <td>M8 DIN 980M ST. STEEL SELF LOCKING NUT</td> <td>1</td> <td>PZ</td> </tr> </tbody> </table>	Code	Description	Qty	UOM	VI1256A0	M8 DIN 980M ST. STEEL SELF LOCKING NUT	1	PZ																																	
Code	Description	Qty	UOM																																						
VI1256A0	M8 DIN 980M ST. STEEL SELF LOCKING NUT	1	PZ																																						
<table border="1"> <thead> <tr> <th>Code</th> <th>Description</th> <th>Qty</th> <th>UOM</th> </tr> </thead> <tbody> <tr> <td>VM1794A0</td> <td>250X4.8 PA66 BLACK CLAMP</td> <td>4</td> <td>PZ</td> </tr> </tbody> </table>	Code	Description	Qty	UOM	VM1794A0	250X4.8 PA66 BLACK CLAMP	4	PZ																																	
Code	Description	Qty	UOM																																						
VM1794A0	250X4.8 PA66 BLACK CLAMP	4	PZ																																						
<table border="1"> <thead> <tr> <th>Code</th> <th>Description</th> <th>Qty</th> <th>UOM</th> </tr> </thead> <tbody> <tr> <td>VM2103A0</td> <td>CLAMP LOCK</td> <td>4</td> <td>PZ</td> </tr> </tbody> </table>	Code	Description	Qty	UOM	VM2103A0	CLAMP LOCK	4	PZ																																	
Code	Description	Qty	UOM																																						
VM2103A0	CLAMP LOCK	4	PZ																																						
<table border="1"> <thead> <tr> <th>Code</th> <th>Description</th> <th>Qty</th> <th>UOM</th> </tr> </thead> <tbody> <tr> <td>VM2196A0</td> <td>MOTOR NUT FIXING BUSHING</td> <td>1</td> <td>PZ</td> </tr> </tbody> </table>	Code	Description	Qty	UOM	VM2196A0	MOTOR NUT FIXING BUSHING	1	PZ																																	
Code	Description	Qty	UOM																																						
VM2196A0	MOTOR NUT FIXING BUSHING	1	PZ																																						
<table border="1"> <thead> <tr> <th>Code</th> <th>Description</th> <th>Qty</th> <th>UOM</th> </tr> </thead> <tbody> <tr> <td>VN1130A1</td> <td>330W 230V 50/60HZ MOTO</td> <td>1</td> <td>PZ</td> </tr> </tbody> </table>	Code	Description	Qty	UOM	VN1130A1	330W 230V 50/60HZ MOTO	1	PZ																																	
Code	Description	Qty	UOM																																						
VN1130A1	330W 230V 50/60HZ MOTO	1	PZ																																						
VN1030A	Ø196 H81 38 BLADES MOTOR FA		KVN1030A	SERIES 5/5E XVC-XBC D196 H81 FAN KIT	<table border="1"> <thead> <tr> <th>Code</th> <th>Description</th> <th>Qty</th> <th>UOM</th> </tr> </thead> <tbody> <tr> <td>VI1256A0</td> <td>M8 DIN 980M ST. STEEL SELF LOCKING NUT</td> <td>1</td> <td>PZ</td> </tr> <tr> <td>VM2196A0</td> <td>MOTOR NUT FIXING BUSHING</td> <td>1</td> <td>PZ</td> </tr> <tr> <td>VN1030A5</td> <td>Ø196 H81 38 BLADES MOTOR FAN</td> <td>1</td> <td>PZ</td> </tr> </tbody> </table>	Code	Description	Qty	UOM	VI1256A0	M8 DIN 980M ST. STEEL SELF LOCKING NUT	1	PZ	VM2196A0	MOTOR NUT FIXING BUSHING	1	PZ	VN1030A5	Ø196 H81 38 BLADES MOTOR FAN	1	PZ																				
					Code	Description	Qty	UOM																																	
					VI1256A0	M8 DIN 980M ST. STEEL SELF LOCKING NUT	1	PZ																																	
VM2196A0	MOTOR NUT FIXING BUSHING	1	PZ																																						
VN1030A5	Ø196 H81 38 BLADES MOTOR FAN	1	PZ																																						
<table border="1"> <thead> <tr> <th>Code</th> <th>Description</th> <th>Qty</th> <th>UOM</th> </tr> </thead> <tbody> <tr> <td>VI1256A0</td> <td>M8 DIN 980M ST. STEEL SELF LOCKING NUT</td> <td>1</td> <td>PZ</td> </tr> </tbody> </table>	Code	Description	Qty	UOM	VI1256A0	M8 DIN 980M ST. STEEL SELF LOCKING NUT	1	PZ																																	
Code	Description	Qty	UOM																																						
VI1256A0	M8 DIN 980M ST. STEEL SELF LOCKING NUT	1	PZ																																						
<table border="1"> <thead> <tr> <th>Code</th> <th>Description</th> <th>Qty</th> <th>UOM</th> </tr> </thead> <tbody> <tr> <td>VM2196A0</td> <td>MOTOR NUT FIXING BUSHING</td> <td>1</td> <td>PZ</td> </tr> </tbody> </table>	Code	Description	Qty	UOM	VM2196A0	MOTOR NUT FIXING BUSHING	1	PZ																																	
Code	Description	Qty	UOM																																						
VM2196A0	MOTOR NUT FIXING BUSHING	1	PZ																																						



COMPONENT			SPARE PART		
Code	Description	Image	Code	Description	Components list
VM1610A	CLIP TWIST LOCK DIAM. 7,6-10,2 MM		VM1610A0	CLIP TWIST LOCK DIAM. 7,6-10,2 MM	
0H6741A	AISI-304 WIRING SUPPORT BRACKET		0H6741A0	AISI-304 WIRING SUPPORT BRACKET	
0H6740A	AISI-304 MOTOR PROTECTING PANE		0H6740A0	AISI-304 MOTOR PROTECTING PANE	
TB1515A	EXTERNAL HUMIDITY PIPE + RC1165A0				
0H6334A	BL CL COOKING CHAMBER HOLDING BRACKET		0H6334A0	BL CL COOKING CHAMBER HOLDING BRACKET	

COMPONENT			SPARE PART																										
Code	Description	Image	Code	Description	Components list																								
0G1476A	BL CL FAN GUARD SPACER		0G1476A0	BL CL FAN GUARD SPACER																									
RS1261A	BAKERLUX\CHEFLU X MOTOR BREAKING ELEMEN		KRS1261A	122W MOTOR BREAKING ELEMENT KIT	<table border="1"> <thead> <tr> <th>Code</th> <th>Description</th> <th>Qty</th> <th>UOM</th> </tr> </thead> <tbody> <tr> <td>GN1326A1</td> <td>ELEMENT SEALING</td> <td>1</td> <td>PZ</td> </tr> <tr> <td>RS1261A0</td> <td>BAKERLUX\CH EFLUX MOTOR BREAKING ELEMENT</td> <td>1</td> <td>PZ</td> </tr> <tr> <td>SL1045A0</td> <td>S53 BLACK SILICONE - 80ML CARTRIDGE</td> <td>1</td> <td>PZ</td> </tr> <tr> <td>VI1220A1</td> <td>4,2X12 TCB SELF-TAPPIN G SCREW</td> <td>2</td> <td>PZ</td> </tr> <tr> <td>VM2147A0</td> <td>ESD SPONGE PINK SMOOTH 410X343X15 M</td> <td>1</td> <td>PZ</td> </tr> </tbody> </table>	Code	Description	Qty	UOM	GN1326A1	ELEMENT SEALING	1	PZ	RS1261A0	BAKERLUX\CH EFLUX MOTOR BREAKING ELEMENT	1	PZ	SL1045A0	S53 BLACK SILICONE - 80ML CARTRIDGE	1	PZ	VI1220A1	4,2X12 TCB SELF-TAPPIN G SCREW	2	PZ	VM2147A0	ESD SPONGE PINK SMOOTH 410X343X15 M	1	PZ
Code	Description	Qty	UOM																										
GN1326A1	ELEMENT SEALING	1	PZ																										
RS1261A0	BAKERLUX\CH EFLUX MOTOR BREAKING ELEMENT	1	PZ																										
SL1045A0	S53 BLACK SILICONE - 80ML CARTRIDGE	1	PZ																										
VI1220A1	4,2X12 TCB SELF-TAPPIN G SCREW	2	PZ																										
VM2147A0	ESD SPONGE PINK SMOOTH 410X343X15 M	1	PZ																										
VM1820A	LATERAL SUPPORTS M6 FIXING BOLTS		KVM1820A	S.5 CHROMIUM PL. THUB SCREWS 10PCS KIT	<table border="1"> <thead> <tr> <th>Code</th> <th>Description</th> <th>Qty</th> <th>UOM</th> </tr> </thead> <tbody> <tr> <td>VM1820A0</td> <td>LATERAL SUPPORTS M6 FIXING BOLTS</td> <td>10</td> <td>PZ</td> </tr> </tbody> </table>	Code	Description	Qty	UOM	VM1820A0	LATERAL SUPPORTS M6 FIXING BOLTS	10	PZ																
Code	Description	Qty	UOM																										
VM1820A0	LATERAL SUPPORTS M6 FIXING BOLTS	10	PZ																										
GRL1265A	LEFT LATERAL SUPPORT 10 600X40		KGRL1265A	10TRAYS 60X40 LATERAL SUPPORT KIT	<table border="1"> <thead> <tr> <th>Code</th> <th>Description</th> <th>Qty</th> <th>UOM</th> </tr> </thead> <tbody> <tr> <td>0H4215A0</td> <td>TRAYS GUIDE PROFILE L372.5 BT</td> <td>20</td> <td>PZ</td> </tr> <tr> <td>0H4420A0</td> <td>STAINLESS STEEL CORE TEMPERATUR</td> <td>1</td> <td>PZ</td> </tr> <tr> <td>0H6709A1</td> <td>0H6495A+0H6 496A FLAT SUPPORTING PROFILE</td> <td>2</td> <td>PZ</td> </tr> <tr> <td>0H6710A1</td> <td>0H6497A+0H6 498A FLAT SUPPORTING PROFILE</td> <td>2</td> <td>PZ</td> </tr> </tbody> </table>	Code	Description	Qty	UOM	0H4215A0	TRAYS GUIDE PROFILE L372.5 BT	20	PZ	0H4420A0	STAINLESS STEEL CORE TEMPERATUR	1	PZ	0H6709A1	0H6495A+0H6 496A FLAT SUPPORTING PROFILE	2	PZ	0H6710A1	0H6497A+0H6 498A FLAT SUPPORTING PROFILE	2	PZ				
Code	Description	Qty	UOM																										
0H4215A0	TRAYS GUIDE PROFILE L372.5 BT	20	PZ																										
0H4420A0	STAINLESS STEEL CORE TEMPERATUR	1	PZ																										
0H6709A1	0H6495A+0H6 496A FLAT SUPPORTING PROFILE	2	PZ																										
0H6710A1	0H6497A+0H6 498A FLAT SUPPORTING PROFILE	2	PZ																										

COMPONENT			SPARE PART																														
Code	Description	Image	Code	Description	Components list																												
GRL1266A	RIGHT LATERAL SUPPORT 10 600X40		KGRL1265A	10TRAYS 60X40 LATERAL SUPPORT KIT	<table border="1"> <thead> <tr> <th>Code</th> <th>Description</th> <th>Qty</th> <th>UOM</th> </tr> </thead> <tbody> <tr> <td>0H4215A0</td> <td>TRAYS GUIDE PROFILE L372.5 BT</td> <td>20</td> <td>PZ</td> </tr> <tr> <td>0H4420A0</td> <td>STAINLESS STEEL CORE TEMPERATUR</td> <td>1</td> <td>PZ</td> </tr> <tr> <td>0H6709A1</td> <td>0H6495A+0H6 496A FLAT SUPPORTING PROFILE</td> <td>2</td> <td>PZ</td> </tr> <tr> <td>0H6710A1</td> <td>0H6497A+0H6 498A FLAT SUPPORTING PROFILE</td> <td>2</td> <td>PZ</td> </tr> </tbody> </table>	Code	Description	Qty	UOM	0H4215A0	TRAYS GUIDE PROFILE L372.5 BT	20	PZ	0H4420A0	STAINLESS STEEL CORE TEMPERATUR	1	PZ	0H6709A1	0H6495A+0H6 496A FLAT SUPPORTING PROFILE	2	PZ	0H6710A1	0H6497A+0H6 498A FLAT SUPPORTING PROFILE	2	PZ								
Code	Description	Qty	UOM																														
0H4215A0	TRAYS GUIDE PROFILE L372.5 BT	20	PZ																														
0H4420A0	STAINLESS STEEL CORE TEMPERATUR	1	PZ																														
0H6709A1	0H6495A+0H6 496A FLAT SUPPORTING PROFILE	2	PZ																														
0H6710A1	0H6497A+0H6 498A FLAT SUPPORTING PROFILE	2	PZ																														
GN1343C	XBC805E DOOR GASKET - GN1006A		KGN1343C	800-2000 SERIES DOOR GASKET KIT	<table border="1"> <thead> <tr> <th>Code</th> <th>Description</th> <th>Qty</th> <th>UOM</th> </tr> </thead> <tbody> <tr> <td>GN1006A1</td> <td>DOOR GASKE</td> <td>3.090</td> <td>M</td> </tr> <tr> <td>GN1007A2</td> <td></td> <td>1</td> <td>M</td> </tr> <tr> <td>GN1008A0</td> <td>DOOR SEAL INTERNAL CONNECTION</td> <td>0.030</td> <td>M</td> </tr> <tr> <td>GN1110A2</td> <td>LINE MISS/XVC105-055/XK/XL DOOR GASKE</td> <td>1</td> <td>M</td> </tr> <tr> <td>SL1025A0</td> <td>CLEAR SILICON DOW CORNING 734</td> <td>0.012</td> <td>PZ</td> </tr> <tr> <td>VM2277A0</td> <td>DOOR SEAL KIT INTERNAL CONNECTION</td> <td>1</td> <td>PZ</td> </tr> </tbody> </table>	Code	Description	Qty	UOM	GN1006A1	DOOR GASKE	3.090	M	GN1007A2		1	M	GN1008A0	DOOR SEAL INTERNAL CONNECTION	0.030	M	GN1110A2	LINE MISS/XVC105-055/XK/XL DOOR GASKE	1	M	SL1025A0	CLEAR SILICON DOW CORNING 734	0.012	PZ	VM2277A0	DOOR SEAL KIT INTERNAL CONNECTION	1	PZ
Code	Description	Qty	UOM																														
GN1006A1	DOOR GASKE	3.090	M																														
GN1007A2		1	M																														
GN1008A0	DOOR SEAL INTERNAL CONNECTION	0.030	M																														
GN1110A2	LINE MISS/XVC105-055/XK/XL DOOR GASKE	1	M																														
SL1025A0	CLEAR SILICON DOW CORNING 734	0.012	PZ																														
VM2277A0	DOOR SEAL KIT INTERNAL CONNECTION	1	PZ																														
OG1473A	XB89- XV89- FAN GUARD		OG1473A0	XB89- XV89- FAN GUARD																													
TB2191A	XB89- XV89- INTERNAL HUMIDITY PIPE		TB2191A0	XB89- XV89- INTERNAL HUMIDITY PIPE																													

ASM2755A/0.D00 - External cover





ASM2755A/0.D00 - External cover

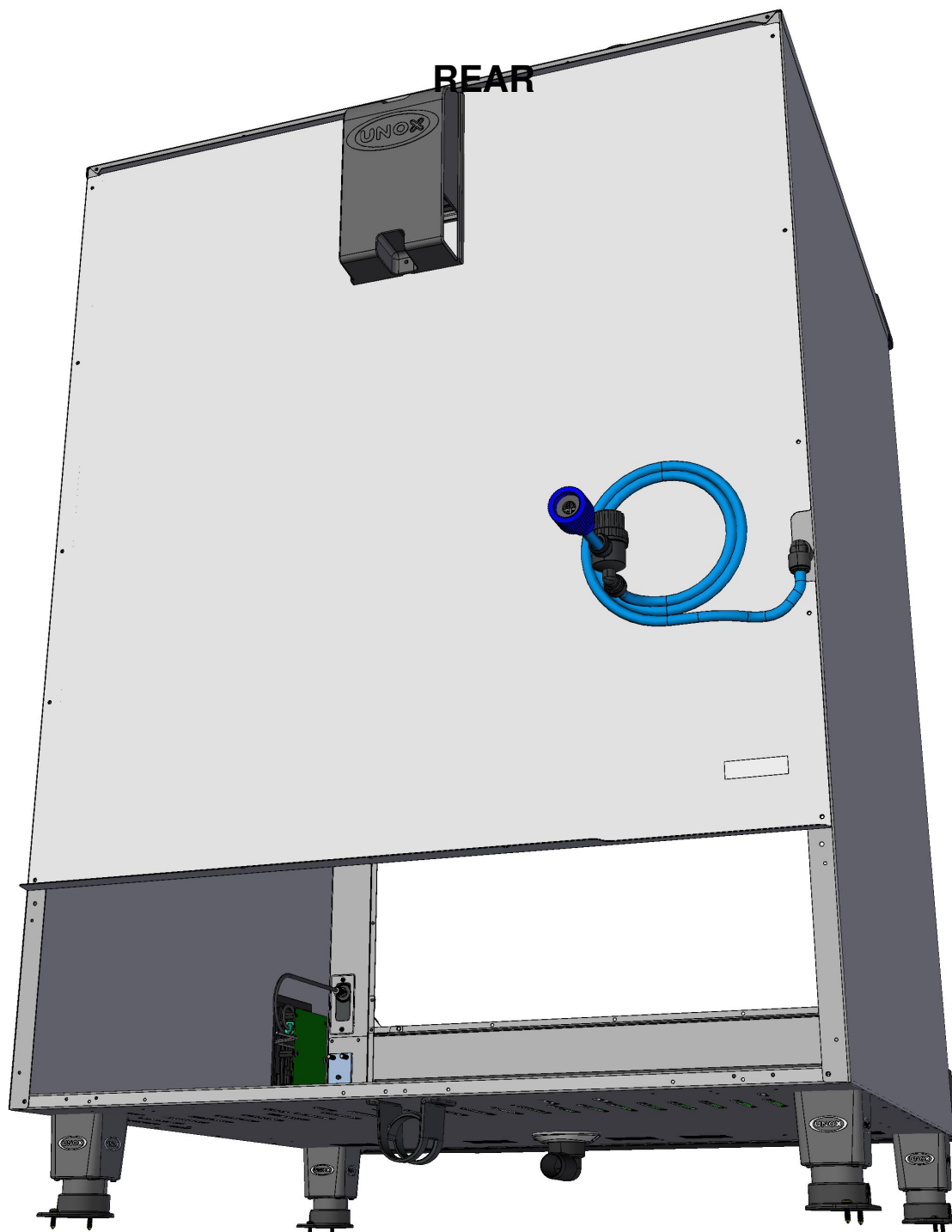





COMPONENT			SPARE PART																		
Code	Description	Image	Code	Description	Components list																
0H1450A	XB-XV-XG ST. STEEL MUFFLE FRONT CORNER		0H1450A0	XB-XV-XG ST. STEEL MUFFLE FRONT CORNER																	
VI1081A	M6X25 STAINLESS STEEL SCREW		KVI1081A	10PCS. M6X25 ST.STEEL SCREW KI	<table border="1"> <thead> <tr> <th>Code</th> <th>Description</th> <th>Qty</th> <th>UOM</th> </tr> </thead> <tbody> <tr> <td>VI1081A0</td> <td>M6X25 STAINLESS STEEL SCREW</td> <td>10</td> <td>PZ</td> </tr> </tbody> </table>	Code	Description	Qty	UOM	VI1081A0	M6X25 STAINLESS STEEL SCREW	10	PZ								
Code	Description	Qty	UOM																		
VI1081A0	M6X25 STAINLESS STEEL SCREW	10	PZ																		
EL1195B	Ø8F-Ø8M ELBOW CONNECTION		KEL1195B	Ø8F-Ø8M ELBOW FITTING 10 PCS KIT	<table border="1"> <thead> <tr> <th>Code</th> <th>Description</th> <th>Qty</th> <th>UOM</th> </tr> </thead> <tbody> <tr> <td>EL1195A0</td> <td>ELBOW UNION Ø8F-Ø8M</td> <td>10</td> <td>PZ</td> </tr> <tr> <td>EL1195B0</td> <td>Ø8F-Ø8M ELBOW CONNECTION</td> <td>10</td> <td>PZ</td> </tr> </tbody> </table>	Code	Description	Qty	UOM	EL1195A0	ELBOW UNION Ø8F-Ø8M	10	PZ	EL1195B0	Ø8F-Ø8M ELBOW CONNECTION	10	PZ				
Code	Description	Qty	UOM																		
EL1195A0	ELBOW UNION Ø8F-Ø8M	10	PZ																		
EL1195B0	Ø8F-Ø8M ELBOW CONNECTION	10	PZ																		
			KEL1195A	Ø8F-Ø8M ELBOW FITTING 10 PCS KIT	<table border="1"> <thead> <tr> <th>Code</th> <th>Description</th> <th>Qty</th> <th>UOM</th> </tr> </thead> <tbody> <tr> <td>EL1195A0</td> <td>ELBOW UNION Ø8F-Ø8M</td> <td>10</td> <td>PZ</td> </tr> </tbody> </table>	Code	Description	Qty	UOM	EL1195A0	ELBOW UNION Ø8F-Ø8M	10	PZ								
Code	Description	Qty	UOM																		
EL1195A0	ELBOW UNION Ø8F-Ø8M	10	PZ																		
RC1002A	JG 10M-8F TERMINAL REDUCTION FITTIN		KRC1002A	REDUCING FITTING SPIGOT 10 PCS KIT	<table border="1"> <thead> <tr> <th>Code</th> <th>Description</th> <th>Qty</th> <th>UOM</th> </tr> </thead> <tbody> <tr> <td>RC1002A0</td> <td>JG 10M-8F TERMINAL REDUCTION FITTING</td> <td>10</td> <td>PZ</td> </tr> </tbody> </table>	Code	Description	Qty	UOM	RC1002A0	JG 10M-8F TERMINAL REDUCTION FITTING	10	PZ								
Code	Description	Qty	UOM																		
RC1002A0	JG 10M-8F TERMINAL REDUCTION FITTING	10	PZ																		
VL1026A	BEND FOR DRAIN PIPE		KVL1026A	DRAIN PIPE BEND KI	<table border="1"> <thead> <tr> <th>Code</th> <th>Description</th> <th>Qty</th> <th>UOM</th> </tr> </thead> <tbody> <tr> <td>GN1400A0</td> <td>U-TRAP SEAL</td> <td>1</td> <td>PZ</td> </tr> <tr> <td>VL1026A0</td> <td>BEND FOR DRAIN PIPE</td> <td>1</td> <td>PZ</td> </tr> <tr> <td>VM2039A0</td> <td>DRAIN BEND FIXING RING</td> <td>1</td> <td>PZ</td> </tr> </tbody> </table>	Code	Description	Qty	UOM	GN1400A0	U-TRAP SEAL	1	PZ	VL1026A0	BEND FOR DRAIN PIPE	1	PZ	VM2039A0	DRAIN BEND FIXING RING	1	PZ
Code	Description	Qty	UOM																		
GN1400A0	U-TRAP SEAL	1	PZ																		
VL1026A0	BEND FOR DRAIN PIPE	1	PZ																		
VM2039A0	DRAIN BEND FIXING RING	1	PZ																		



COMPONENT			SPARE PART																										
Code	Description	Image	Code	Description	Components list																								
VM2039A	DRAIN BEND FIXING RING		KVL1026A	DRAIN PIPE BEND KI	<table border="1"> <thead> <tr> <th>Code</th> <th>Description</th> <th>Qty</th> <th>UOM</th> </tr> </thead> <tbody> <tr> <td>GN1400A0</td> <td>U-TRAP SEAL</td> <td>1</td> <td>PZ</td> </tr> <tr> <td>VL1026A0</td> <td>BEND FOR DRAIN PIPE</td> <td>1</td> <td>PZ</td> </tr> <tr> <td>VM2039A0</td> <td>DRAIN BEND FIXING RING</td> <td>1</td> <td>PZ</td> </tr> </tbody> </table>	Code	Description	Qty	UOM	GN1400A0	U-TRAP SEAL	1	PZ	VL1026A0	BEND FOR DRAIN PIPE	1	PZ	VM2039A0	DRAIN BEND FIXING RING	1	PZ								
Code	Description	Qty	UOM																										
GN1400A0	U-TRAP SEAL	1	PZ																										
VL1026A0	BEND FOR DRAIN PIPE	1	PZ																										
VM2039A0	DRAIN BEND FIXING RING	1	PZ																										
VM1190A	CT BT RIGHT DOOR SPRING LATCH		KVM1190A	CHEFTOP/BAKERTO P DOOR RIGHT LATCH KIT	<table border="1"> <thead> <tr> <th>Code</th> <th>Description</th> <th>Qty</th> <th>UOM</th> </tr> </thead> <tbody> <tr> <td>VI0239A1</td> <td>SELF-TAPPIN G SCREW 4.2X25 TCB+ INOX</td> <td>2</td> <td>PZ</td> </tr> <tr> <td>VI1220A1</td> <td>4,2X12 TCB SELF-TAPPIN G SCREW</td> <td>2</td> <td>PZ</td> </tr> <tr> <td>VM1190A2</td> <td>CT BT RIGHT DOOR SPRING LATCH</td> <td>1</td> <td>PZ</td> </tr> <tr> <td>VM1192A1</td> <td>CT BT DOOR SPRING LATCH BACK COVER</td> <td>1</td> <td>PZ</td> </tr> <tr> <td>VM1460A0</td> <td>XBC/XVC RIGHT DOOR LATCH CAP</td> <td>1</td> <td>PZ</td> </tr> </tbody> </table>	Code	Description	Qty	UOM	VI0239A1	SELF-TAPPIN G SCREW 4.2X25 TCB+ INOX	2	PZ	VI1220A1	4,2X12 TCB SELF-TAPPIN G SCREW	2	PZ	VM1190A2	CT BT RIGHT DOOR SPRING LATCH	1	PZ	VM1192A1	CT BT DOOR SPRING LATCH BACK COVER	1	PZ	VM1460A0	XBC/XVC RIGHT DOOR LATCH CAP	1	PZ
Code	Description	Qty	UOM																										
VI0239A1	SELF-TAPPIN G SCREW 4.2X25 TCB+ INOX	2	PZ																										
VI1220A1	4,2X12 TCB SELF-TAPPIN G SCREW	2	PZ																										
VM1190A2	CT BT RIGHT DOOR SPRING LATCH	1	PZ																										
VM1192A1	CT BT DOOR SPRING LATCH BACK COVER	1	PZ																										
VM1460A0	XBC/XVC RIGHT DOOR LATCH CAP	1	PZ																										
VM1240A	NYLON SUPPORT CAP		KVM1240A	4 PCS COUNTER BRACKET SUPPORT CAP KIT	<table border="1"> <thead> <tr> <th>Code</th> <th>Description</th> <th>Qty</th> <th>UOM</th> </tr> </thead> <tbody> <tr> <td>VM1240A0</td> <td>NYLON SUPPORT CAP</td> <td>4</td> <td>PZ</td> </tr> </tbody> </table>	Code	Description	Qty	UOM	VM1240A0	NYLON SUPPORT CAP	4	PZ																
Code	Description	Qty	UOM																										
VM1240A0	NYLON SUPPORT CAP	4	PZ																										
VM1195A	HOLES BLANKING PLATE XVC204/304/504/704		VM1195A0	HOLES BLANKING PLATE XVC204/304/504/704																									



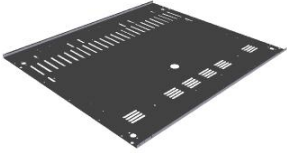

COMPONENT			SPARE PART																										
Code	Description	Image	Code	Description	Components list																								
VM1191A	CT BT LEFT DOOR SPRING LATCH		KVM1191A	CHEFTOP/BAKERTO P DOOR LEFT LATCH KIT	<table border="1"> <thead> <tr> <th>Code</th> <th>Description</th> <th>Qty</th> <th>UOM</th> </tr> </thead> <tbody> <tr> <td>VI0239A1</td> <td>SELF-TAPPIN G SCREW 4.2X25 TCB+ INOX</td> <td>2</td> <td>PZ</td> </tr> <tr> <td>VI1220A1</td> <td>4,2X12 TCB SELF-TAPPIN G SCREW</td> <td>2</td> <td>PZ</td> </tr> <tr> <td>VM1191A2</td> <td>CT BT LEFT DOOR SPRING LATCH</td> <td>1</td> <td>PZ</td> </tr> <tr> <td>VM1192A1</td> <td>CT BT DOOR SPRING LATCH BACK COVER</td> <td>1</td> <td>PZ</td> </tr> <tr> <td>VM1460A0</td> <td>XBC/XVC RIGHT DOOR LATCH CAP</td> <td>1</td> <td>PZ</td> </tr> </tbody> </table>	Code	Description	Qty	UOM	VI0239A1	SELF-TAPPIN G SCREW 4.2X25 TCB+ INOX	2	PZ	VI1220A1	4,2X12 TCB SELF-TAPPIN G SCREW	2	PZ	VM1191A2	CT BT LEFT DOOR SPRING LATCH	1	PZ	VM1192A1	CT BT DOOR SPRING LATCH BACK COVER	1	PZ	VM1460A0	XBC/XVC RIGHT DOOR LATCH CAP	1	PZ
					Code	Description	Qty	UOM																					
					VI0239A1	SELF-TAPPIN G SCREW 4.2X25 TCB+ INOX	2	PZ																					
					VI1220A1	4,2X12 TCB SELF-TAPPIN G SCREW	2	PZ																					
					VM1191A2	CT BT LEFT DOOR SPRING LATCH	1	PZ																					
VM1192A1	CT BT DOOR SPRING LATCH BACK COVER	1	PZ																										
VM1460A0	XBC/XVC RIGHT DOOR LATCH CAP	1	PZ																										
VM1165B	CT BT DOOR UPPER BRACKET		KVM1165B	CT BT CL BL DOOR UPPER BRACKET KI	<table border="1"> <thead> <tr> <th>Code</th> <th>Description</th> <th>Qty</th> <th>UOM</th> </tr> </thead> <tbody> <tr> <td>VM1165B0</td> <td>CT BT DOOR UPPER BRACKET</td> <td>1</td> <td>PZ</td> </tr> </tbody> </table>	Code	Description	Qty	UOM	VM1165B0	CT BT DOOR UPPER BRACKET	1	PZ																
					Code	Description	Qty	UOM																					
VM1165B0	CT BT DOOR UPPER BRACKET	1	PZ																										
VM1166A	CAP FOR DOOR UPPER STIRRUP XVC204/304/5		KVM1166A	DOOR UPPER BRACKET COVER KI	<table border="1"> <thead> <tr> <th>Code</th> <th>Description</th> <th>Qty</th> <th>UOM</th> </tr> </thead> <tbody> <tr> <td>VM1166A0</td> <td>CAP FOR DOOR UPPER STIRRUP XVC204/304/5</td> <td>1</td> <td>PZ</td> </tr> </tbody> </table>	Code	Description	Qty	UOM	VM1166A0	CAP FOR DOOR UPPER STIRRUP XVC204/304/5	1	PZ																
					Code	Description	Qty	UOM																					
VM1166A0	CAP FOR DOOR UPPER STIRRUP XVC204/304/5	1	PZ																										
0E1331B	CHEFLUX-BAKERLUX EXTERNAL BOTTOM PANEL		0E1331B0	CHEFLUX-BAKERLUX EXTERNAL BOTTOM PANEL																									











COMPONENT			SPARE PART																		
Code	Description	Image	Code	Description	Components list																
0D2125A	BAKERLUX CHEFLUX COVER		0D2125A0	BAKERLUX CHEFLUX COVER																	
0H2560A	XBC/XVC ZINC PLAT. DOOR COUNTERBRACKET		0H2560A0	XBC/XVC ZINC PLAT. DOOR COUNTERBRACKET																	
VM1460A	XBC/XVC RIGHT DOOR LATCH CAP		KVM1460A	XBC/XVC RIGHT DOOR LATCH CAP KIT	<table border="1"> <thead> <tr> <th>Code</th> <th>Description</th> <th>Qty</th> <th>UOM</th> </tr> </thead> <tbody> <tr> <td>VI0239A1</td> <td>SELF-TAPPIN G SCREW 4.2X25 TCB+ INOX</td> <td>2</td> <td>PZ</td> </tr> <tr> <td>VM1460A0</td> <td>XBC/XVC RIGHT DOOR LATCH CAP</td> <td>1</td> <td>PZ</td> </tr> </tbody> </table>	Code	Description	Qty	UOM	VI0239A1	SELF-TAPPIN G SCREW 4.2X25 TCB+ INOX	2	PZ	VM1460A0	XBC/XVC RIGHT DOOR LATCH CAP	1	PZ				
Code	Description	Qty	UOM																		
VI0239A1	SELF-TAPPIN G SCREW 4.2X25 TCB+ INOX	2	PZ																		
VM1460A0	XBC/XVC RIGHT DOOR LATCH CAP	1	PZ																		
VM1461A	XBC/XVC LEFT DOOR LATCH CAP		VM1461A0	XBC/XVC LEFT DOOR LATCH CAP																	
VN1165A	230VAC 50/60HZ COOLING DOWN FA		KVN1165A	230V 120X120 COOLING FAN KIT	<table border="1"> <thead> <tr> <th>Code</th> <th>Description</th> <th>Qty</th> <th>UOM</th> </tr> </thead> <tbody> <tr> <td>VI1099A0</td> <td>SELF-DRILLIN G SCREW 4.8X13 TCB+ Z</td> <td>4</td> <td>PZ</td> </tr> <tr> <td>VM1555A2</td> <td>CT BT COOLING FAN SUPPORT</td> <td>1</td> <td>PZ</td> </tr> <tr> <td>VN1165A0</td> <td>230VAC 50/60HZ COOLING DOWN FAN</td> <td>1</td> <td>PZ</td> </tr> </tbody> </table>	Code	Description	Qty	UOM	VI1099A0	SELF-DRILLIN G SCREW 4.8X13 TCB+ Z	4	PZ	VM1555A2	CT BT COOLING FAN SUPPORT	1	PZ	VN1165A0	230VAC 50/60HZ COOLING DOWN FAN	1	PZ
Code	Description	Qty	UOM																		
VI1099A0	SELF-DRILLIN G SCREW 4.8X13 TCB+ Z	4	PZ																		
VM1555A2	CT BT COOLING FAN SUPPORT	1	PZ																		
VN1165A0	230VAC 50/60HZ COOLING DOWN FAN	1	PZ																		







COMPONENT			SPARE PART										
Code	Description	Image	Code	Description	Components list								
VM1556A	XBC-XVC COOLING FAN GUARD		KVM1556A	XBC-XVC COOLING FAN GUARD KIT	<table border="1"> <thead> <tr> <th>Code</th> <th>Description</th> <th>Qty</th> <th>UOM</th> </tr> </thead> <tbody> <tr> <td>VM1556A0</td> <td>XBC-XVC COOLING FAN GUARD</td> <td>1</td> <td>PZ</td> </tr> </tbody> </table>	Code	Description	Qty	UOM	VM1556A0	XBC-XVC COOLING FAN GUARD	1	PZ
Code	Description	Qty	UOM										
VM1556A0	XBC-XVC COOLING FAN GUARD	1	PZ										
VM1555A	CT BT COOLING FAN SUPPORT												
0H6240A	BAKERLUX CHEFLUX ST. STEEL CONTROL PANEL		0H6240A0	BAKERLUX CHEFLUX ST. STEEL CONTROL PANEL									
VM1975A	DOOR SUPPORT LOWER BRACKET		KVM1975A	CL BL DOOR LOWER BRACKET KIT	<table border="1"> <thead> <tr> <th>Code</th> <th>Description</th> <th>Qty</th> <th>UOM</th> </tr> </thead> <tbody> <tr> <td>VM1975A0</td> <td>DOOR SUPPORT LOWER BRACKET</td> <td>1</td> <td>PZ</td> </tr> </tbody> </table>	Code	Description	Qty	UOM	VM1975A0	DOOR SUPPORT LOWER BRACKET	1	PZ
Code	Description	Qty	UOM										
VM1975A0	DOOR SUPPORT LOWER BRACKET	1	PZ										
VM1974A	BOARD CLOSING PLATE		VM1974A0	BOARD CLOSING PLATE									

COMPONENT			SPARE PART																																		
Code	Description	Image	Code	Description	Components list																																
VM2194C	BAKERLUX DYNAMIC COMPLETE CONTROL BOARD		KVM2194C	BAKERLUX DYNAMIC CONTROL BOARD KIT	<table border="1"> <thead> <tr> <th>Code</th> <th>Description</th> <th>Qty</th> <th>UOM</th> </tr> </thead> <tbody> <tr> <td>VM1794A0</td> <td>250X4.8 PA66 BLACK CLAMP</td> <td>2</td> <td>PZ</td> </tr> <tr> <td>VM2103A0</td> <td>CLAMP LOCK</td> <td>2</td> <td>PZ</td> </tr> <tr> <td>VM2194C0</td> <td>BAKERLUX DYNAMIC COMPLETE CONTROL BOARD</td> <td>1</td> <td>PZ</td> </tr> <tr> <td>VM2194C1</td> <td>BAKERLUX DYNAMIC COMPLETE CONTROL BOARD</td> <td>1</td> <td>PZ</td> </tr> </tbody> </table>	Code	Description	Qty	UOM	VM1794A0	250X4.8 PA66 BLACK CLAMP	2	PZ	VM2103A0	CLAMP LOCK	2	PZ	VM2194C0	BAKERLUX DYNAMIC COMPLETE CONTROL BOARD	1	PZ	VM2194C1	BAKERLUX DYNAMIC COMPLETE CONTROL BOARD	1	PZ												
					Code	Description	Qty	UOM																													
VM1794A0	250X4.8 PA66 BLACK CLAMP	2	PZ																																		
VM2103A0	CLAMP LOCK	2	PZ																																		
VM2194C0	BAKERLUX DYNAMIC COMPLETE CONTROL BOARD	1	PZ																																		
VM2194C1	BAKERLUX DYNAMIC COMPLETE CONTROL BOARD	1	PZ																																		
CE1305A	L=2MT RJ45 - RJ45 CABLE		KCE1305A	RJ45 - RJ45 L=2MT CABLE KIT	<table border="1"> <thead> <tr> <th>Code</th> <th>Description</th> <th>Qty</th> <th>UOM</th> </tr> </thead> <tbody> <tr> <td>CE1305A0</td> <td>L=2MT RJ45 - RJ45 CABLE</td> <td>1</td> <td>PZ</td> </tr> </tbody> </table>	Code	Description	Qty	UOM	CE1305A0	L=2MT RJ45 - RJ45 CABLE	1	PZ																								
Code	Description	Qty	UOM																																		
CE1305A0	L=2MT RJ45 - RJ45 CABLE	1	PZ																																		
VE1020A	MAGNETIC DOOR MICROSWITCH		KVE1020B	MICROSWITCH KIT	<table border="1"> <thead> <tr> <th>Code</th> <th>Description</th> <th>Qty</th> <th>UOM</th> </tr> </thead> <tbody> <tr> <td>CE1030A0</td> <td>FEMALE FASTON COVER 6.3X0.8 0.5-1MMQ</td> <td>2</td> <td>PZ</td> </tr> <tr> <td>CE1660A0</td> <td>6,3X0,8 FEMALE FASTON COVE</td> <td>2</td> <td>PZ</td> </tr> <tr> <td>CE1730A0</td> <td>PVC CABLE NP 2 X AWG22 STYLE 2095</td> <td>0.150</td> <td>M</td> </tr> <tr> <td>CE1740A0</td> <td>MINIFIT MALE END FITTING</td> <td>2</td> <td>PZ</td> </tr> <tr> <td>CE1745A0</td> <td>2 WAYS FEMALE MINIFIT CONNECTOR</td> <td>1</td> <td>PZ</td> </tr> <tr> <td>VE1020B0</td> <td>MAGNET DOOR MICROSWITC</td> <td>1</td> <td>PZ</td> </tr> <tr> <td>VE1030A1</td> <td>MAGNET FOR DOOR MICROSWITC H D=22,9MM</td> <td>1</td> <td>PZ</td> </tr> </tbody> </table>	Code	Description	Qty	UOM	CE1030A0	FEMALE FASTON COVER 6.3X0.8 0.5-1MMQ	2	PZ	CE1660A0	6,3X0,8 FEMALE FASTON COVE	2	PZ	CE1730A0	PVC CABLE NP 2 X AWG22 STYLE 2095	0.150	M	CE1740A0	MINIFIT MALE END FITTING	2	PZ	CE1745A0	2 WAYS FEMALE MINIFIT CONNECTOR	1	PZ	VE1020B0	MAGNET DOOR MICROSWITC	1	PZ	VE1030A1	MAGNET FOR DOOR MICROSWITC H D=22,9MM	1	PZ
					Code	Description	Qty	UOM																													
					CE1030A0	FEMALE FASTON COVER 6.3X0.8 0.5-1MMQ	2	PZ																													
					CE1660A0	6,3X0,8 FEMALE FASTON COVE	2	PZ																													
					CE1730A0	PVC CABLE NP 2 X AWG22 STYLE 2095	0.150	M																													
					CE1740A0	MINIFIT MALE END FITTING	2	PZ																													
					CE1745A0	2 WAYS FEMALE MINIFIT CONNECTOR	1	PZ																													
					VE1020B0	MAGNET DOOR MICROSWITC	1	PZ																													
			VE1030A1	MAGNET FOR DOOR MICROSWITC H D=22,9MM	1	PZ																															
			KVE1020A	MICROSWITCH KIT	<table border="1"> <thead> <tr> <th>Code</th> <th>Description</th> <th>Qty</th> <th>UOM</th> </tr> </thead> <tbody> <tr> <td>VE1020A2</td> <td>MAGNETIC DOOR MICROSWITC</td> <td>1</td> <td>PZ</td> </tr> <tr> <td>VE1030A1</td> <td>MAGNET FOR DOOR MICROSWITC H D=22,9MM</td> <td>4</td> <td>PZ</td> </tr> </tbody> </table>	Code	Description	Qty	UOM	VE1020A2	MAGNETIC DOOR MICROSWITC	1	PZ	VE1030A1	MAGNET FOR DOOR MICROSWITC H D=22,9MM	4	PZ																				
Code	Description	Qty			UOM																																
VE1020A2	MAGNETIC DOOR MICROSWITC	1	PZ																																		
VE1030A1	MAGNET FOR DOOR MICROSWITC H D=22,9MM	4	PZ																																		



COMPONENT			SPARE PART																		
Code	Description	Image	Code	Description	Components list																
VM1201A	DOOR MAGNETIC MICROSWITCH SUPPORT PLATE																				
0H6333A	BL CL THREADED DOOR COUNTER BRACKET		0H6333A0	BL CL THREADED DOOR COUNTER BRACKET																	
TB2808A	TB1815A0-D8 H2O SOLENOID LUX 0,5M		TB2808A0	TB1815A0-D8 H2O SOLENOID LUX 0,5M																	
RC1365A	3/4"-10 JG FEMALE CONNECTION		KRC1365A	3/4"-10 OR 8 JG FEMALE CONNECTION KI	<table border="1"> <thead> <tr> <th>Code</th> <th>Description</th> <th>Qty</th> <th>UOM</th> </tr> </thead> <tbody> <tr> <td>GN1200A1</td> <td>3/4 CONNECTION SEAL D=24 RUBBER+NET</td> <td>1</td> <td>PZ</td> </tr> <tr> <td>RC1002A0</td> <td>JG 10M-8F TERMINAL REDUCTION FITTING</td> <td>1</td> <td>PZ</td> </tr> <tr> <td>RC1365A0</td> <td>3/4"-10 JG FEMALE CONNECTION</td> <td>1</td> <td>PZ</td> </tr> </tbody> </table>	Code	Description	Qty	UOM	GN1200A1	3/4 CONNECTION SEAL D=24 RUBBER+NET	1	PZ	RC1002A0	JG 10M-8F TERMINAL REDUCTION FITTING	1	PZ	RC1365A0	3/4"-10 JG FEMALE CONNECTION	1	PZ
Code	Description	Qty	UOM																		
GN1200A1	3/4 CONNECTION SEAL D=24 RUBBER+NET	1	PZ																		
RC1002A0	JG 10M-8F TERMINAL REDUCTION FITTING	1	PZ																		
RC1365A0	3/4"-10 JG FEMALE CONNECTION	1	PZ																		
VL1034B	MESH WATER FILTER D10		KVL1034C	Ø8-Ø10 MESH100 WATER FILTER KIT	<table border="1"> <thead> <tr> <th>Code</th> <th>Description</th> <th>Qty</th> <th>UOM</th> </tr> </thead> <tbody> <tr> <td>RC1002A0</td> <td>JG 10M-8F TERMINAL REDUCTION FITTING</td> <td>2</td> <td>PZ</td> </tr> <tr> <td>VL1034C0</td> <td>MESH WATER FILTER D10</td> <td>1</td> <td>PZ</td> </tr> <tr> <td>VL1062C0</td> <td>PRESSURE REDUCER-FIL TER LOCKING FORK</td> <td>1</td> <td>PZ</td> </tr> </tbody> </table>	Code	Description	Qty	UOM	RC1002A0	JG 10M-8F TERMINAL REDUCTION FITTING	2	PZ	VL1034C0	MESH WATER FILTER D10	1	PZ	VL1062C0	PRESSURE REDUCER-FIL TER LOCKING FORK	1	PZ
Code	Description	Qty	UOM																		
RC1002A0	JG 10M-8F TERMINAL REDUCTION FITTING	2	PZ																		
VL1034C0	MESH WATER FILTER D10	1	PZ																		
VL1062C0	PRESSURE REDUCER-FIL TER LOCKING FORK	1	PZ																		

COMPONENT			SPARE PART																		
Code	Description	Image	Code	Description	Components list																
VL1034B	MESH WATER FILTER D10		KVL1034B	Ø8 AND Ø10 WATER FILTER KIT	<table border="1"> <thead> <tr> <th>Code</th> <th>Description</th> <th>Qty</th> <th>UOM</th> </tr> </thead> <tbody> <tr> <td>RC1002A0</td> <td>JG 10M-8F TERMINAL REDUCTION FITTING</td> <td>2</td> <td>PZ</td> </tr> <tr> <td>VL1034B0</td> <td>MESH WATER FILTER D10</td> <td>1</td> <td>PZ</td> </tr> <tr> <td>VL1062C0</td> <td>PRESSURE REDUCER-FILTER LOCKING FORK</td> <td>1</td> <td>PZ</td> </tr> </tbody> </table>	Code	Description	Qty	UOM	RC1002A0	JG 10M-8F TERMINAL REDUCTION FITTING	2	PZ	VL1034B0	MESH WATER FILTER D10	1	PZ	VL1062C0	PRESSURE REDUCER-FILTER LOCKING FORK	1	PZ
					Code	Description	Qty	UOM													
					RC1002A0	JG 10M-8F TERMINAL REDUCTION FITTING	2	PZ													
VL1034B0	MESH WATER FILTER D10	1	PZ																		
VL1062C0	PRESSURE REDUCER-FILTER LOCKING FORK	1	PZ																		
TB2237A	Ø10 WATER MAIN CONNECTION PIPE		KTB2599A	Ø10 PET WATER PIPE TB2243A0 100M KIT	<table border="1"> <thead> <tr> <th>Code</th> <th>Description</th> <th>Qty</th> <th>UOM</th> </tr> </thead> <tbody> <tr> <td>TB2243A0</td> <td>Ø10 PET PIPE</td> <td>100</td> <td>M</td> </tr> <tr> <td>VM1059A1</td> <td>HEAT SHRINK FILM H800</td> <td>1.500</td> <td>M</td> </tr> </tbody> </table>	Code	Description	Qty	UOM	TB2243A0	Ø10 PET PIPE	100	M	VM1059A1	HEAT SHRINK FILM H800	1.500	M				
					Code	Description	Qty	UOM													
					TB2243A0	Ø10 PET PIPE	100	M													
VM1059A1	HEAT SHRINK FILM H800	1.500	M																		
KTB2598A	Ø10 PET HUMIDITY PIPE TB2243A0 3 M KIT	<table border="1"> <thead> <tr> <th>Code</th> <th>Description</th> <th>Qty</th> <th>UOM</th> </tr> </thead> <tbody> <tr> <td>TB2243A0</td> <td>Ø10 PET PIPE</td> <td>3</td> <td>M</td> </tr> </tbody> </table>	Code	Description	Qty	UOM	TB2243A0	Ø10 PET PIPE	3	M											
Code	Description	Qty	UOM																		
TB2243A0	Ø10 PET PIPE	3	M																		
KTB2237A	1,5M D10 TB2243A CONNECTION PIPE	<table border="1"> <thead> <tr> <th>Code</th> <th>Description</th> <th>Qty</th> <th>UOM</th> </tr> </thead> <tbody> <tr> <td>TB2243A0</td> <td>Ø10 PET PIPE</td> <td>1.500</td> <td>M</td> </tr> </tbody> </table>	Code	Description	Qty	UOM	TB2243A0	Ø10 PET PIPE	1.500	M											
Code	Description	Qty	UOM																		
TB2243A0	Ø10 PET PIPE	1.500	M																		
RC1360A	10 - 10 JG ELBOW FITTING		KRC1360A	Ø10 - Ø10 JG ELBOW FITTING 10 PCS KIT	<table border="1"> <thead> <tr> <th>Code</th> <th>Description</th> <th>Qty</th> <th>UOM</th> </tr> </thead> <tbody> <tr> <td>RC1360A0</td> <td>10 - 10 JG ELBOW FITTING</td> <td>10</td> <td>PZ</td> </tr> </tbody> </table>	Code	Description	Qty	UOM	RC1360A0	10 - 10 JG ELBOW FITTING	10	PZ								
Code	Description	Qty	UOM																		
RC1360A0	10 - 10 JG ELBOW FITTING	10	PZ																		
EL1349A	CLIP TO FIX Ø10 MM CONNECTION JOIN		KEL1349A	Ø10 FITTING LOCKING CLIPS 10 PCS KIT	<table border="1"> <thead> <tr> <th>Code</th> <th>Description</th> <th>Qty</th> <th>UOM</th> </tr> </thead> <tbody> <tr> <td>EL1349A0</td> <td>CLIP TO FIX Ø10 MM CONNECTION JOINT</td> <td>10</td> <td>PZ</td> </tr> </tbody> </table>	Code	Description	Qty	UOM	EL1349A0	CLIP TO FIX Ø10 MM CONNECTION JOINT	10	PZ								
Code	Description	Qty	UOM																		
EL1349A0	CLIP TO FIX Ø10 MM CONNECTION JOINT	10	PZ																		



COMPONENT			SPARE PART																		
Code	Description	Image	Code	Description	Components list																
0D2210A	LEFT SIDE PANEL BL CL 89-		0D2210A0	LEFT SIDE PANEL BL CL 89-																	
0F1469A	XB89- XV89- EXTERNAL BACK PANEL		0F1469A0	XB89- XV89- EXTERNAL BACK PANEL																	
PD1066B	BI-COMPONENT FOOT H100 (E SERIES FOOT)		KPD1066B	E SERIES OVEN H100 FOOT KIT	<table border="1"> <thead> <tr> <th>Code</th> <th>Description</th> <th>Qty</th> <th>UOM</th> </tr> </thead> <tbody> <tr> <td>PD1063A0</td> <td>CT BT FOOT STOP BRACKE</td> <td>1</td> <td>PZ</td> </tr> <tr> <td>PD1066B0</td> <td>BI-COMPONE NT FOOT H100 (E SERIES FOOT)</td> <td>1</td> <td>PZ</td> </tr> <tr> <td>VI1220A1</td> <td>4,2X12 TCB SELF-TAPPIN G SCREW</td> <td>5</td> <td>PZ</td> </tr> </tbody> </table>	Code	Description	Qty	UOM	PD1063A0	CT BT FOOT STOP BRACKE	1	PZ	PD1066B0	BI-COMPONE NT FOOT H100 (E SERIES FOOT)	1	PZ	VI1220A1	4,2X12 TCB SELF-TAPPIN G SCREW	5	PZ
Code	Description	Qty	UOM																		
PD1063A0	CT BT FOOT STOP BRACKE	1	PZ																		
PD1066B0	BI-COMPONE NT FOOT H100 (E SERIES FOOT)	1	PZ																		
VI1220A1	4,2X12 TCB SELF-TAPPIN G SCREW	5	PZ																		
PD1063A	CT BT FOOT STOP BRACKET		KPD1063A	OVEN FOOT STOPPING BRACKET KIT	<table border="1"> <thead> <tr> <th>Code</th> <th>Description</th> <th>Qty</th> <th>UOM</th> </tr> </thead> <tbody> <tr> <td>PD1063A0</td> <td>CT BT FOOT STOP BRACKE</td> <td>4</td> <td>PZ</td> </tr> <tr> <td>VI1950A0</td> <td>ST. STEEL 4,2X13 TCB SELF-DRILLIN G SCREW</td> <td>8</td> <td>PZ</td> </tr> </tbody> </table>	Code	Description	Qty	UOM	PD1063A0	CT BT FOOT STOP BRACKE	4	PZ	VI1950A0	ST. STEEL 4,2X13 TCB SELF-DRILLIN G SCREW	8	PZ				
Code	Description	Qty	UOM																		
PD1063A0	CT BT FOOT STOP BRACKE	4	PZ																		
VI1950A0	ST. STEEL 4,2X13 TCB SELF-DRILLIN G SCREW	8	PZ																		
PE1971A	RJ45 CONNECTION + RESET POINT		KPE1967A	S.5E CT-BT UNOX.LINK CARD KI	<table border="1"> <thead> <tr> <th>Code</th> <th>Description</th> <th>Qty</th> <th>UOM</th> </tr> </thead> <tbody> <tr> <td>PE1971A0</td> <td>RJ45 CONNECTION + RESET POIN</td> <td>1</td> <td>PZ</td> </tr> </tbody> </table>	Code	Description	Qty	UOM	PE1971A0	RJ45 CONNECTION + RESET POIN	1	PZ								
Code	Description	Qty	UOM																		
PE1971A0	RJ45 CONNECTION + RESET POIN	1	PZ																		



COMPONENT			SPARE PART										
Code	Description	Image	Code	Description	Components list								
VM2035A	DRAIN PIPE SUPPORT		KVM2035A	DRAIN PIPE SUPPORT 2 PCS. KI	<table border="1"> <thead> <tr> <th>Code</th> <th>Description</th> <th>Qty</th> <th>UOM</th> </tr> </thead> <tbody> <tr> <td>VM2035A0</td> <td>DRAIN PIPE SUPPORT</td> <td>2</td> <td>PZ</td> </tr> </tbody> </table>	Code	Description	Qty	UOM	VM2035A0	DRAIN PIPE SUPPORT	2	PZ
Code	Description	Qty	UOM										
VM2035A0	DRAIN PIPE SUPPORT	2	PZ										
VM2028A	20X10X4 RUBBER WASHER		KVM2028A	20X10X4 RUBBER WASHER 5 PCS. KIT	<table border="1"> <thead> <tr> <th>Code</th> <th>Description</th> <th>Qty</th> <th>UOM</th> </tr> </thead> <tbody> <tr> <td>VM2028A0</td> <td>20X10X4 RUBBER WASHER</td> <td>5</td> <td>PZ</td> </tr> </tbody> </table>	Code	Description	Qty	UOM	VM2028A0	20X10X4 RUBBER WASHER	5	PZ
Code	Description	Qty	UOM										
VM2028A0	20X10X4 RUBBER WASHER	5	PZ										

ASM4080A/0.D00 - Door



ASM4080A/0.D00 - Door

REAR

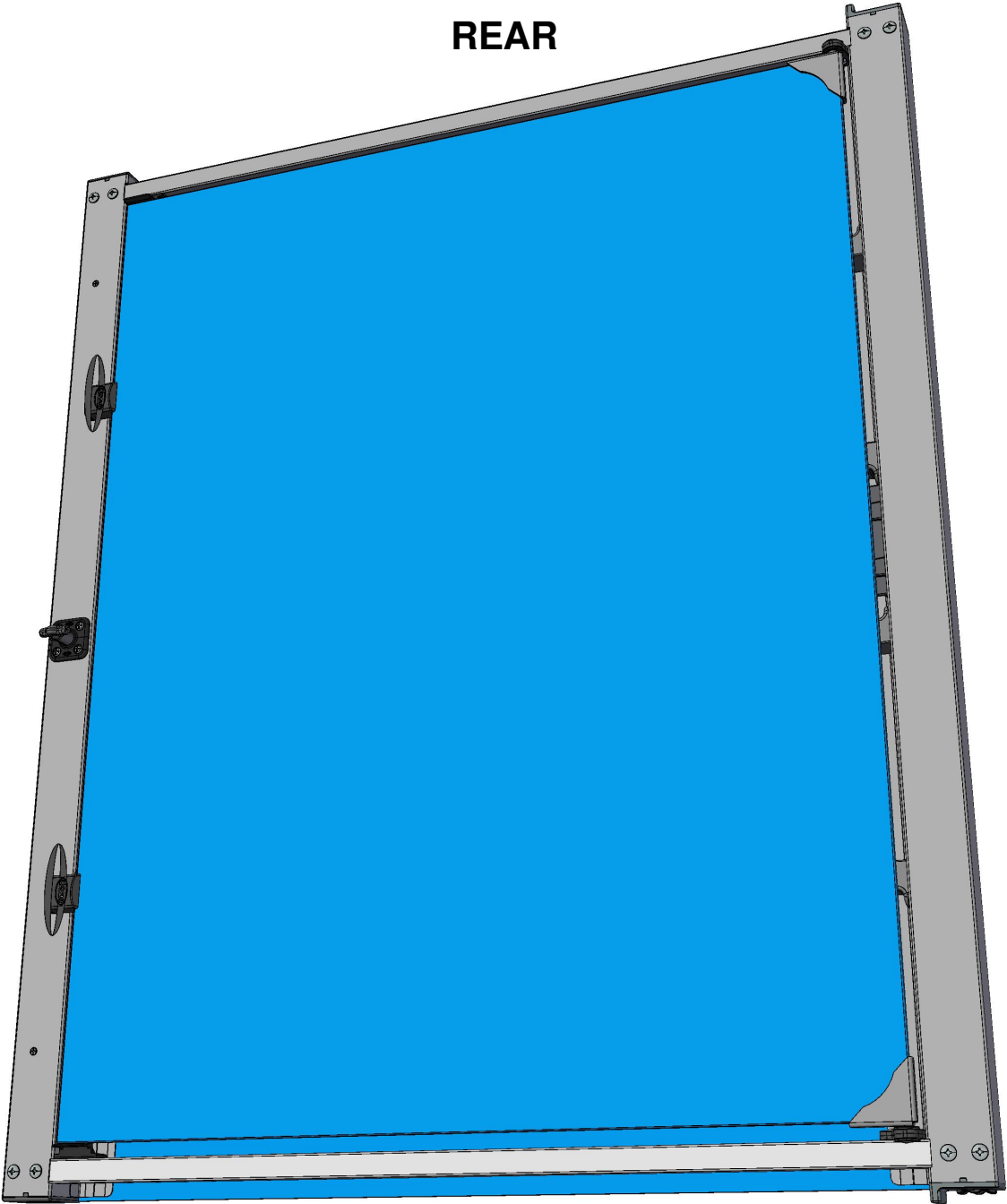





COMPONENT			SPARE PART																										
Code	Description	Image	Code	Description	Components list																								
VM1180B	CHEFTOP/BAKERTO P HANDLE SHAFT		KVM1191A	CHEFTOP/BAKERTO P DOOR LEFT LATCH KIT	<table border="1"> <thead> <tr> <th>Code</th> <th>Description</th> <th>Qty</th> <th>UOM</th> </tr> </thead> <tbody> <tr> <td>VI0239A1</td> <td>SELF-TAPPIN G SCREW 4.2X25 TCB+ INOX</td> <td>2</td> <td>PZ</td> </tr> <tr> <td>VI1220A1</td> <td>4,2X12 TCB SELF-TAPPIN G SCREW</td> <td>2</td> <td>PZ</td> </tr> <tr> <td>VM1191A2</td> <td>CT BT LEFT DOOR SPRING LATCH</td> <td>1</td> <td>PZ</td> </tr> <tr> <td>VM1192A1</td> <td>CT BT DOOR SPRING LATCH BACK COVER</td> <td>1</td> <td>PZ</td> </tr> <tr> <td>VM1460A0</td> <td>XBC/XVC RIGHT DOOR LATCH CAP</td> <td>1</td> <td>PZ</td> </tr> </tbody> </table>	Code	Description	Qty	UOM	VI0239A1	SELF-TAPPIN G SCREW 4.2X25 TCB+ INOX	2	PZ	VI1220A1	4,2X12 TCB SELF-TAPPIN G SCREW	2	PZ	VM1191A2	CT BT LEFT DOOR SPRING LATCH	1	PZ	VM1192A1	CT BT DOOR SPRING LATCH BACK COVER	1	PZ	VM1460A0	XBC/XVC RIGHT DOOR LATCH CAP	1	PZ
			Code	Description	Qty	UOM																							
			VI0239A1	SELF-TAPPIN G SCREW 4.2X25 TCB+ INOX	2	PZ																							
VI1220A1	4,2X12 TCB SELF-TAPPIN G SCREW	2	PZ																										
VM1191A2	CT BT LEFT DOOR SPRING LATCH	1	PZ																										
VM1192A1	CT BT DOOR SPRING LATCH BACK COVER	1	PZ																										
VM1460A0	XBC/XVC RIGHT DOOR LATCH CAP	1	PZ																										
KVM1190A	CHEFTOP/BAKERTO P DOOR RIGHT LATCH KIT	<table border="1"> <thead> <tr> <th>Code</th> <th>Description</th> <th>Qty</th> <th>UOM</th> </tr> </thead> <tbody> <tr> <td>VI0239A1</td> <td>SELF-TAPPIN G SCREW 4.2X25 TCB+ INOX</td> <td>2</td> <td>PZ</td> </tr> <tr> <td>VI1220A1</td> <td>4,2X12 TCB SELF-TAPPIN G SCREW</td> <td>2</td> <td>PZ</td> </tr> <tr> <td>VM1190A2</td> <td>CT BT RIGHT DOOR SPRING LATCH</td> <td>1</td> <td>PZ</td> </tr> <tr> <td>VM1192A1</td> <td>CT BT DOOR SPRING LATCH BACK COVER</td> <td>1</td> <td>PZ</td> </tr> <tr> <td>VM1460A0</td> <td>XBC/XVC RIGHT DOOR LATCH CAP</td> <td>1</td> <td>PZ</td> </tr> </tbody> </table>	Code	Description	Qty	UOM	VI0239A1	SELF-TAPPIN G SCREW 4.2X25 TCB+ INOX	2	PZ	VI1220A1	4,2X12 TCB SELF-TAPPIN G SCREW	2	PZ	VM1190A2	CT BT RIGHT DOOR SPRING LATCH	1	PZ	VM1192A1	CT BT DOOR SPRING LATCH BACK COVER	1	PZ	VM1460A0	XBC/XVC RIGHT DOOR LATCH CAP	1	PZ			
Code	Description	Qty	UOM																										
VI0239A1	SELF-TAPPIN G SCREW 4.2X25 TCB+ INOX	2	PZ																										
VI1220A1	4,2X12 TCB SELF-TAPPIN G SCREW	2	PZ																										
VM1190A2	CT BT RIGHT DOOR SPRING LATCH	1	PZ																										
VM1192A1	CT BT DOOR SPRING LATCH BACK COVER	1	PZ																										
VM1460A0	XBC/XVC RIGHT DOOR LATCH CAP	1	PZ																										
KVM1180B	CT BT CL BL HANDLE KIT	<table border="1"> <thead> <tr> <th>Code</th> <th>Description</th> <th>Qty</th> <th>UOM</th> </tr> </thead> <tbody> <tr> <td>0H3000B0</td> <td>E.S. CT BT STAINLESS STEEL HANDLE COVE</td> <td>1</td> <td>PZ</td> </tr> <tr> <td>RC1200A0</td> <td>ED=4 WIRE D.=0.5 COMPRESSIO N SPRING</td> <td>4</td> <td>PZ</td> </tr> <tr> <td>VM1180B0</td> <td>CHEFTOP/BAK ERTOP HANDLE SHAF</td> <td>1</td> <td>PZ</td> </tr> <tr> <td>VM1181B0</td> <td>E SERIES CT BT HANDLE SHAFT CAP</td> <td>1</td> <td>PZ</td> </tr> </tbody> </table>	Code	Description	Qty	UOM	0H3000B0	E.S. CT BT STAINLESS STEEL HANDLE COVE	1	PZ	RC1200A0	ED=4 WIRE D.=0.5 COMPRESSIO N SPRING	4	PZ	VM1180B0	CHEFTOP/BAK ERTOP HANDLE SHAF	1	PZ	VM1181B0	E SERIES CT BT HANDLE SHAFT CAP	1	PZ							
Code	Description	Qty	UOM																										
0H3000B0	E.S. CT BT STAINLESS STEEL HANDLE COVE	1	PZ																										
RC1200A0	ED=4 WIRE D.=0.5 COMPRESSIO N SPRING	4	PZ																										
VM1180B0	CHEFTOP/BAK ERTOP HANDLE SHAF	1	PZ																										
VM1181B0	E SERIES CT BT HANDLE SHAFT CAP	1	PZ																										





COMPONENT			SPARE PART																																																							
Code	Description	Image	Code	Description	Components list																																																					
VM1180B	CHEFTOP/BAKERTO P HANDLE SHAFT		KVM1180B	CT BT CL BL HANDLE KIT	<table border="1"> <thead> <tr> <th>Code</th> <th>Description</th> <th>Qty</th> <th>UOM</th> </tr> </thead> <tbody> <tr> <td>VM1182B0</td> <td>E S. CT BT HANDLE JUNCTION + PIN GUIDE</td> <td>1</td> <td>PZ</td> </tr> <tr> <td>VM1182B1</td> <td>E S. CT BT HANDLE JUNCTION + PIN GUIDE</td> <td>1</td> <td>PZ</td> </tr> <tr> <td>VM1183A1</td> <td>CHEFTOP/BAK ERTOP HANDLE PIN</td> <td>1</td> <td>PZ</td> </tr> <tr> <td>VM1695A0</td> <td>HANDLE POSITION PIN</td> <td>4</td> <td>PZ</td> </tr> </tbody> </table>	Code	Description	Qty	UOM	VM1182B0	E S. CT BT HANDLE JUNCTION + PIN GUIDE	1	PZ	VM1182B1	E S. CT BT HANDLE JUNCTION + PIN GUIDE	1	PZ	VM1183A1	CHEFTOP/BAK ERTOP HANDLE PIN	1	PZ	VM1695A0	HANDLE POSITION PIN	4	PZ																																	
			Code	Description	Qty	UOM																																																				
VM1182B0	E S. CT BT HANDLE JUNCTION + PIN GUIDE	1	PZ																																																							
VM1182B1	E S. CT BT HANDLE JUNCTION + PIN GUIDE	1	PZ																																																							
VM1183A1	CHEFTOP/BAK ERTOP HANDLE PIN	1	PZ																																																							
VM1695A0	HANDLE POSITION PIN	4	PZ																																																							
KMG1030B	CT BT CL BL HANDLE KIT	<table border="1"> <thead> <tr> <th>Code</th> <th>Description</th> <th>Qty</th> <th>UOM</th> </tr> </thead> <tbody> <tr> <td>0H7321A0</td> <td>MM STAINLESS STEEL HANDLE COVE</td> <td>1</td> <td>PZ</td> </tr> <tr> <td>ED1072A0</td> <td></td> <td>1</td> <td>PZ</td> </tr> <tr> <td>RC1200A0</td> <td>ED=4 WIRE D.=0.5 COMPRESSIO N SPRING</td> <td>4</td> <td>PZ</td> </tr> <tr> <td>VI0239A1</td> <td>SELF-TAPPIN G SCREW 4.2X25 TCB+ INOX</td> <td>4</td> <td>PZ</td> </tr> <tr> <td>VI1220A1</td> <td>4,2X12 TCB SELF-TAPPIN G SCREW</td> <td>2</td> <td>PZ</td> </tr> <tr> <td>VM1182B1</td> <td>E S. CT BT HANDLE JUNCTION + PIN GUIDE</td> <td>1</td> <td>PZ</td> </tr> <tr> <td>VM1183B0</td> <td>CHEFTOP/BAK ERTOP HANDLE PIN</td> <td>1</td> <td>PZ</td> </tr> <tr> <td>VM1490A0</td> <td>CHEFTOP/BAK ERTOP HANDLE SCREWS COVER</td> <td>2</td> <td>PZ</td> </tr> <tr> <td>VM1695A0</td> <td>HANDLE POSITION PIN</td> <td>4</td> <td>PZ</td> </tr> <tr> <td>VM2245A0</td> <td>HANDLE SHAFT WITH LATCH</td> <td>1</td> <td>PZ</td> </tr> <tr> <td>VM2247A0</td> <td>HANDLE SHAFT COVER VM2245-2246</td> <td>1</td> <td>PZ</td> </tr> <tr> <td>VM2248B0</td> <td>CLOSING HANDLE KEY WITH LATCH</td> <td>1</td> <td>PZ</td> </tr> <tr> <td>VM2295A0</td> <td>STYLUS PEN FOR MM</td> <td>1</td> <td>PZ</td> </tr> </tbody> </table>	Code	Description	Qty	UOM	0H7321A0	MM STAINLESS STEEL HANDLE COVE	1	PZ	ED1072A0		1	PZ	RC1200A0	ED=4 WIRE D.=0.5 COMPRESSIO N SPRING	4	PZ	VI0239A1	SELF-TAPPIN G SCREW 4.2X25 TCB+ INOX	4	PZ	VI1220A1	4,2X12 TCB SELF-TAPPIN G SCREW	2	PZ	VM1182B1	E S. CT BT HANDLE JUNCTION + PIN GUIDE	1	PZ	VM1183B0	CHEFTOP/BAK ERTOP HANDLE PIN	1	PZ	VM1490A0	CHEFTOP/BAK ERTOP HANDLE SCREWS COVER	2	PZ	VM1695A0	HANDLE POSITION PIN	4	PZ	VM2245A0	HANDLE SHAFT WITH LATCH	1	PZ	VM2247A0	HANDLE SHAFT COVER VM2245-2246	1	PZ	VM2248B0	CLOSING HANDLE KEY WITH LATCH	1	PZ	VM2295A0	STYLUS PEN FOR MM	1	PZ
Code	Description	Qty	UOM																																																							
0H7321A0	MM STAINLESS STEEL HANDLE COVE	1	PZ																																																							
ED1072A0		1	PZ																																																							
RC1200A0	ED=4 WIRE D.=0.5 COMPRESSIO N SPRING	4	PZ																																																							
VI0239A1	SELF-TAPPIN G SCREW 4.2X25 TCB+ INOX	4	PZ																																																							
VI1220A1	4,2X12 TCB SELF-TAPPIN G SCREW	2	PZ																																																							
VM1182B1	E S. CT BT HANDLE JUNCTION + PIN GUIDE	1	PZ																																																							
VM1183B0	CHEFTOP/BAK ERTOP HANDLE PIN	1	PZ																																																							
VM1490A0	CHEFTOP/BAK ERTOP HANDLE SCREWS COVER	2	PZ																																																							
VM1695A0	HANDLE POSITION PIN	4	PZ																																																							
VM2245A0	HANDLE SHAFT WITH LATCH	1	PZ																																																							
VM2247A0	HANDLE SHAFT COVER VM2245-2246	1	PZ																																																							
VM2248B0	CLOSING HANDLE KEY WITH LATCH	1	PZ																																																							
VM2295A0	STYLUS PEN FOR MM	1	PZ																																																							



COMPONENT			SPARE PART																																						
Code	Description	Image	Code	Description	Components list																																				
VM1181B	E SERIES CT BT HANDLE SHAFT CAP		KVM1180B	CT BT CL BL HANDLE KIT	<table border="1"> <thead> <tr> <th>Code</th> <th>Description</th> <th>Qty</th> <th>UOM</th> </tr> </thead> <tbody> <tr> <td>0H3000B0</td> <td>E S. CT BT STAINLESS STEEL HANDLE COVE</td> <td>1</td> <td>PZ</td> </tr> <tr> <td>RC1200A0</td> <td>ED=4 WIRE D.=0.5 COMPRESSIO N SPRING</td> <td>4</td> <td>PZ</td> </tr> <tr> <td>VM1180B0</td> <td>CHEFTOP/BAK ERTOP HANDLE SHAF</td> <td>1</td> <td>PZ</td> </tr> <tr> <td>VM1181B0</td> <td>E SERIES CT BT HANDLE SHAFT CAP</td> <td>1</td> <td>PZ</td> </tr> <tr> <td>VM1182B0</td> <td>E S. CT BT HANDLE JUNCTION + PIN GUIDE</td> <td>1</td> <td>PZ</td> </tr> <tr> <td>VM1182B1</td> <td>E S. CT BT HANDLE JUNCTION + PIN GUIDE</td> <td>1</td> <td>PZ</td> </tr> <tr> <td>VM1183A1</td> <td>CHEFTOP/BAK ERTOP HANDLE PIN</td> <td>1</td> <td>PZ</td> </tr> <tr> <td>VM1695A0</td> <td>HANDLE POSITION PIN</td> <td>4</td> <td>PZ</td> </tr> </tbody> </table>	Code	Description	Qty	UOM	0H3000B0	E S. CT BT STAINLESS STEEL HANDLE COVE	1	PZ	RC1200A0	ED=4 WIRE D.=0.5 COMPRESSIO N SPRING	4	PZ	VM1180B0	CHEFTOP/BAK ERTOP HANDLE SHAF	1	PZ	VM1181B0	E SERIES CT BT HANDLE SHAFT CAP	1	PZ	VM1182B0	E S. CT BT HANDLE JUNCTION + PIN GUIDE	1	PZ	VM1182B1	E S. CT BT HANDLE JUNCTION + PIN GUIDE	1	PZ	VM1183A1	CHEFTOP/BAK ERTOP HANDLE PIN	1	PZ	VM1695A0	HANDLE POSITION PIN	4	PZ
			Code	Description	Qty	UOM																																			
0H3000B0	E S. CT BT STAINLESS STEEL HANDLE COVE	1	PZ																																						
RC1200A0	ED=4 WIRE D.=0.5 COMPRESSIO N SPRING	4	PZ																																						
VM1180B0	CHEFTOP/BAK ERTOP HANDLE SHAF	1	PZ																																						
VM1181B0	E SERIES CT BT HANDLE SHAFT CAP	1	PZ																																						
VM1182B0	E S. CT BT HANDLE JUNCTION + PIN GUIDE	1	PZ																																						
VM1182B1	E S. CT BT HANDLE JUNCTION + PIN GUIDE	1	PZ																																						
VM1183A1	CHEFTOP/BAK ERTOP HANDLE PIN	1	PZ																																						
VM1695A0	HANDLE POSITION PIN	4	PZ																																						
KMG1030B	CT BT CL BL HANDLE KIT	<table border="1"> <thead> <tr> <th>Code</th> <th>Description</th> <th>Qty</th> <th>UOM</th> </tr> </thead> <tbody> <tr> <td>0H7321A0</td> <td>MM STAINLESS STEEL HANDLE COVE</td> <td>1</td> <td>PZ</td> </tr> <tr> <td>ED1072A0</td> <td></td> <td>1</td> <td>PZ</td> </tr> <tr> <td>RC1200A0</td> <td>ED=4 WIRE D.=0.5 COMPRESSIO N SPRING</td> <td>4</td> <td>PZ</td> </tr> <tr> <td>VI0239A1</td> <td>SELF-TAPPIN G SCREW 4.2X25 TCB+ INOX</td> <td>4</td> <td>PZ</td> </tr> <tr> <td>VI1220A1</td> <td>4,2X12 TCB SELF-TAPPIN G SCREW</td> <td>2</td> <td>PZ</td> </tr> <tr> <td>VM1182B1</td> <td>E S. CT BT HANDLE JUNCTION + PIN GUIDE</td> <td>1</td> <td>PZ</td> </tr> <tr> <td>VM1183B0</td> <td>CHEFTOP/BAK ERTOP HANDLE PIN</td> <td>1</td> <td>PZ</td> </tr> </tbody> </table>	Code	Description	Qty	UOM	0H7321A0	MM STAINLESS STEEL HANDLE COVE	1	PZ	ED1072A0		1	PZ	RC1200A0	ED=4 WIRE D.=0.5 COMPRESSIO N SPRING	4	PZ	VI0239A1	SELF-TAPPIN G SCREW 4.2X25 TCB+ INOX	4	PZ	VI1220A1	4,2X12 TCB SELF-TAPPIN G SCREW	2	PZ	VM1182B1	E S. CT BT HANDLE JUNCTION + PIN GUIDE	1	PZ	VM1183B0	CHEFTOP/BAK ERTOP HANDLE PIN	1	PZ							
Code	Description	Qty	UOM																																						
0H7321A0	MM STAINLESS STEEL HANDLE COVE	1	PZ																																						
ED1072A0		1	PZ																																						
RC1200A0	ED=4 WIRE D.=0.5 COMPRESSIO N SPRING	4	PZ																																						
VI0239A1	SELF-TAPPIN G SCREW 4.2X25 TCB+ INOX	4	PZ																																						
VI1220A1	4,2X12 TCB SELF-TAPPIN G SCREW	2	PZ																																						
VM1182B1	E S. CT BT HANDLE JUNCTION + PIN GUIDE	1	PZ																																						
VM1183B0	CHEFTOP/BAK ERTOP HANDLE PIN	1	PZ																																						

COMPONENT			SPARE PART																														
Code	Description	Image	Code	Description	Components list																												
VM1181B	E SERIES CT BT HANDLE SHAFT CAP		KMG1030B	CT BT CL BL HANDLE KIT	<table border="1"> <thead> <tr> <th>Code</th> <th>Description</th> <th>Qty</th> <th>UOM</th> </tr> </thead> <tbody> <tr> <td>VM1490A0</td> <td>CHEFTOP/BAK ERTOP HANDLE SCREWS COVER</td> <td>2</td> <td>PZ</td> </tr> <tr> <td>VM1695A0</td> <td>HANDLE POSITION PIN</td> <td>4</td> <td>PZ</td> </tr> <tr> <td>VM2245A0</td> <td>HANDLE SHAFT WITH LATCH</td> <td>1</td> <td>PZ</td> </tr> <tr> <td>VM2247A0</td> <td>HANDLE SHAFT COVER VM2245-2246</td> <td>1</td> <td>PZ</td> </tr> <tr> <td>VM2248B0</td> <td>CLOSING HANDLE KEY WITH LATCH</td> <td>1</td> <td>PZ</td> </tr> <tr> <td>VM2295A0</td> <td>STYLUS PEN FOR MM</td> <td>1</td> <td>PZ</td> </tr> </tbody> </table>	Code	Description	Qty	UOM	VM1490A0	CHEFTOP/BAK ERTOP HANDLE SCREWS COVER	2	PZ	VM1695A0	HANDLE POSITION PIN	4	PZ	VM2245A0	HANDLE SHAFT WITH LATCH	1	PZ	VM2247A0	HANDLE SHAFT COVER VM2245-2246	1	PZ	VM2248B0	CLOSING HANDLE KEY WITH LATCH	1	PZ	VM2295A0	STYLUS PEN FOR MM	1	PZ
					Code	Description	Qty	UOM																									
					VM1490A0	CHEFTOP/BAK ERTOP HANDLE SCREWS COVER	2	PZ																									
					VM1695A0	HANDLE POSITION PIN	4	PZ																									
					VM2245A0	HANDLE SHAFT WITH LATCH	1	PZ																									
					VM2247A0	HANDLE SHAFT COVER VM2245-2246	1	PZ																									
					VM2248B0	CLOSING HANDLE KEY WITH LATCH	1	PZ																									
VM2295A0	STYLUS PEN FOR MM	1	PZ																														
VM1630A	INTERNAL GLASS PUSHING CAP		KVM2315A	MM INTERNAL GLASS SUPPORT KI	<table border="1"> <thead> <tr> <th>Code</th> <th>Description</th> <th>Qty</th> <th>UOM</th> </tr> </thead> <tbody> <tr> <td>VI1220A1</td> <td>4,2X12 TCB SELF-TAPPIN G SCREW</td> <td>3</td> <td>PZ</td> </tr> <tr> <td>VM1630A0</td> <td>INTERNAL GLASS PUSHING CAP</td> <td>3</td> <td>PZ</td> </tr> <tr> <td>VM2315A0</td> <td>6 S. INTERNAL GLASS CAP SUPPORT</td> <td>3</td> <td>PZ</td> </tr> </tbody> </table>	Code	Description	Qty	UOM	VI1220A1	4,2X12 TCB SELF-TAPPIN G SCREW	3	PZ	VM1630A0	INTERNAL GLASS PUSHING CAP	3	PZ	VM2315A0	6 S. INTERNAL GLASS CAP SUPPORT	3	PZ												
					Code	Description	Qty	UOM																									
					VI1220A1	4,2X12 TCB SELF-TAPPIN G SCREW	3	PZ																									
			VM1630A0	INTERNAL GLASS PUSHING CAP	3	PZ																											
			VM2315A0	6 S. INTERNAL GLASS CAP SUPPORT	3	PZ																											
			KVM1630A	CAP FOR INTERNAL GLASS 10 PCS KIT	<table border="1"> <thead> <tr> <th>Code</th> <th>Description</th> <th>Qty</th> <th>UOM</th> </tr> </thead> <tbody> <tr> <td>VM1630A0</td> <td>INTERNAL GLASS PUSHING CAP</td> <td>10</td> <td>PZ</td> </tr> </tbody> </table>	Code	Description	Qty	UOM	VM1630A0	INTERNAL GLASS PUSHING CAP	10	PZ																				
					Code	Description	Qty	UOM																									
			VM1630A0	INTERNAL GLASS PUSHING CAP	10	PZ																											
			KVM1591A	S.5E INT. GLASS H35 PUSHING BRACKET KIT	<table border="1"> <thead> <tr> <th>Code</th> <th>Description</th> <th>Qty</th> <th>UOM</th> </tr> </thead> <tbody> <tr> <td>VI1220A1</td> <td>4,2X12 TCB SELF-TAPPIN G SCREW</td> <td>2</td> <td>PZ</td> </tr> <tr> <td>VM1591A0</td> <td>GLASS BRACKET INT. XVC1004</td> <td>1</td> <td>PZ</td> </tr> <tr> <td>VM1630A0</td> <td>INTERNAL GLASS PUSHING CAP</td> <td>2</td> <td>PZ</td> </tr> </tbody> </table>	Code	Description	Qty	UOM	VI1220A1	4,2X12 TCB SELF-TAPPIN G SCREW	2	PZ	VM1591A0	GLASS BRACKET INT. XVC1004	1	PZ	VM1630A0	INTERNAL GLASS PUSHING CAP	2	PZ												
					Code	Description	Qty	UOM																									
VI1220A1	4,2X12 TCB SELF-TAPPIN G SCREW	2			PZ																												
VM1591A0	GLASS BRACKET INT. XVC1004	1			PZ																												
VM1630A0	INTERNAL GLASS PUSHING CAP	2			PZ																												
KVM1590A	S.5 INT. GLASS H25 PUSHING BRACKET KIT	<table border="1"> <thead> <tr> <th>Code</th> <th>Description</th> <th>Qty</th> <th>UOM</th> </tr> </thead> <tbody> <tr> <td>VI1220A1</td> <td>4,2X12 TCB SELF-TAPPIN G SCREW</td> <td>2</td> <td>PZ</td> </tr> </tbody> </table>	Code	Description	Qty	UOM	VI1220A1	4,2X12 TCB SELF-TAPPIN G SCREW	2	PZ																							
		Code	Description	Qty	UOM																												
VI1220A1	4,2X12 TCB SELF-TAPPIN G SCREW	2	PZ																														

COMPONENT			SPARE PART																		
Code	Description	Image	Code	Description	Components list																
VM1630A	INTERNAL GLASS PUSHING CAP		KVM1590A	S.5 INT. GLASS H25 PUSHING BRACKET KIT	<table border="1"> <thead> <tr> <th>Code</th> <th>Description</th> <th>Qty</th> <th>UOM</th> </tr> </thead> <tbody> <tr> <td>VM1590A0</td> <td>XVC705 XBC805 GLASS PUSHING BRACKET</td> <td>1</td> <td>PZ</td> </tr> <tr> <td>VM1630A0</td> <td>INTERNAL GLASS PUSHING CAP</td> <td>2</td> <td>PZ</td> </tr> </tbody> </table>	Code	Description	Qty	UOM	VM1590A0	XVC705 XBC805 GLASS PUSHING BRACKET	1	PZ	VM1630A0	INTERNAL GLASS PUSHING CAP	2	PZ				
Code	Description	Qty	UOM																		
VM1590A0	XVC705 XBC805 GLASS PUSHING BRACKET	1	PZ																		
VM1630A0	INTERNAL GLASS PUSHING CAP	2	PZ																		
VM1591A	GLASS BRACKET INT. XVC1004		KVM1591A	S.5E INT. GLASS H35 PUSHING BRACKET KIT	<table border="1"> <thead> <tr> <th>Code</th> <th>Description</th> <th>Qty</th> <th>UOM</th> </tr> </thead> <tbody> <tr> <td>VH1220A1</td> <td>4,2X12 TCB SELF-TAPPIN G SCREW</td> <td>2</td> <td>PZ</td> </tr> <tr> <td>VM1591A0</td> <td>GLASS BRACKET INT. XVC1004</td> <td>1</td> <td>PZ</td> </tr> <tr> <td>VM1630A0</td> <td>INTERNAL GLASS PUSHING CAP</td> <td>2</td> <td>PZ</td> </tr> </tbody> </table>	Code	Description	Qty	UOM	VH1220A1	4,2X12 TCB SELF-TAPPIN G SCREW	2	PZ	VM1591A0	GLASS BRACKET INT. XVC1004	1	PZ	VM1630A0	INTERNAL GLASS PUSHING CAP	2	PZ
Code	Description	Qty	UOM																		
VH1220A1	4,2X12 TCB SELF-TAPPIN G SCREW	2	PZ																		
VM1591A0	GLASS BRACKET INT. XVC1004	1	PZ																		
VM1630A0	INTERNAL GLASS PUSHING CAP	2	PZ																		
VM1511A	XBC/XVC SLEEK DOOR PIN BUSHING		KVM1511A	BUSHING KIT VM1511A0 5PC	<table border="1"> <thead> <tr> <th>Code</th> <th>Description</th> <th>Qty</th> <th>UOM</th> </tr> </thead> <tbody> <tr> <td>VM1511A0</td> <td>XBC/XVC SLEEK DOOR PIN BUSHING</td> <td>5</td> <td>PZ</td> </tr> </tbody> </table>	Code	Description	Qty	UOM	VM1511A0	XBC/XVC SLEEK DOOR PIN BUSHING	5	PZ								
Code	Description	Qty	UOM																		
VM1511A0	XBC/XVC SLEEK DOOR PIN BUSHING	5	PZ																		
VM1510A	XBC/XVC GROOVED DOOR PIN BUSHING		KVM1510A	GROOVED DOOR PIN BUSHING 5 PCS KIT	<table border="1"> <thead> <tr> <th>Code</th> <th>Description</th> <th>Qty</th> <th>UOM</th> </tr> </thead> <tbody> <tr> <td>VM1510A0</td> <td>XBC/XVC GROOVED DOOR PIN BUSHING</td> <td>5</td> <td>PZ</td> </tr> </tbody> </table>	Code	Description	Qty	UOM	VM1510A0	XBC/XVC GROOVED DOOR PIN BUSHING	5	PZ								
Code	Description	Qty	UOM																		
VM1510A0	XBC/XVC GROOVED DOOR PIN BUSHING	5	PZ																		
TB2384B	BAKERLUX CHEFLUX DOOR UPPER LISTEL		TB2384B0	BAKERLUX CHEFLUX DOOR UPPER LISTEL																	

COMPONENT			SPARE PART																																																		
Code	Description	Image	Code	Description	Components list																																																
TB2404A	BAKERLUX CHEFLUX DOOR LOWER LISTEL		TB2404A0	BAKERLUX CHEFLUX DOOR LOWER LISTEL																																																	
VM1977A	CL BL DOOR UPPER FULCRUM-CAP		KVM1977A	CL BL DOOR UPPER FULCRUM-CAP KIT	<table border="1"> <thead> <tr> <th>Code</th> <th>Description</th> <th>Qty</th> <th>UOM</th> </tr> </thead> <tbody> <tr> <td>VM1977A0</td> <td>CL BL DOOR UPPER FULCRUM-CA</td> <td>1</td> <td>PZ</td> </tr> </tbody> </table>	Code	Description	Qty	UOM	VM1977A0	CL BL DOOR UPPER FULCRUM-CA	1	PZ																																								
Code	Description	Qty	UOM																																																		
VM1977A0	CL BL DOOR UPPER FULCRUM-CA	1	PZ																																																		
			KDR1254A	XB893 XV893 COMPLETE DOOR	<table border="1"> <thead> <tr> <th>Code</th> <th>Description</th> <th>Qty</th> <th>UOM</th> </tr> </thead> <tbody> <tr> <td>0H3000B0</td> <td>E S. CT BT STAINLESS STEEL HANDLE COVE</td> <td>1</td> <td>PZ</td> </tr> <tr> <td>0H6575A1</td> <td>XB89- XV EXTERNAL GLASS HOLDING PROFILE</td> <td>2</td> <td>PZ</td> </tr> <tr> <td>0H7321A0</td> <td>MM STAINLESS STEEL HANDLE COVE</td> <td>1</td> <td>PZ</td> </tr> <tr> <td>CR1085A0</td> <td>INTERNAL GLASS UPPER HINGE</td> <td>1</td> <td>PZ</td> </tr> <tr> <td>CR1086A0</td> <td>INTERNAL GLASS LOWER HINGE</td> <td>1</td> <td>PZ</td> </tr> <tr> <td>ED1072A0</td> <td></td> <td>1</td> <td>PZ</td> </tr> <tr> <td>GN1181A0</td> <td>INTERNAL GLASS HINGE SEAL</td> <td>2</td> <td>PZ</td> </tr> <tr> <td>RC1200A0</td> <td>ED=4 WIRE D.=0.5 COMPRESSIO N SPRING</td> <td>8</td> <td>PZ</td> </tr> <tr> <td>SL1110A0</td> <td>BIADHESIVE PIN 3M VHB 9473-PC</td> <td>1</td> <td>PZ</td> </tr> <tr> <td>TB2384B0</td> <td>BAKERLUX CHEFLUX DOOR UPPER LISTEL</td> <td>1</td> <td>PZ</td> </tr> <tr> <td>TB2385A0</td> <td>BL CL 89- RIGHT DOOR COLUMN 50X50X1.2</td> <td>1</td> <td>PZ</td> </tr> </tbody> </table>	Code	Description	Qty	UOM	0H3000B0	E S. CT BT STAINLESS STEEL HANDLE COVE	1	PZ	0H6575A1	XB89- XV EXTERNAL GLASS HOLDING PROFILE	2	PZ	0H7321A0	MM STAINLESS STEEL HANDLE COVE	1	PZ	CR1085A0	INTERNAL GLASS UPPER HINGE	1	PZ	CR1086A0	INTERNAL GLASS LOWER HINGE	1	PZ	ED1072A0		1	PZ	GN1181A0	INTERNAL GLASS HINGE SEAL	2	PZ	RC1200A0	ED=4 WIRE D.=0.5 COMPRESSIO N SPRING	8	PZ	SL1110A0	BIADHESIVE PIN 3M VHB 9473-PC	1	PZ	TB2384B0	BAKERLUX CHEFLUX DOOR UPPER LISTEL	1	PZ	TB2385A0	BL CL 89- RIGHT DOOR COLUMN 50X50X1.2	1	PZ
Code	Description	Qty	UOM																																																		
0H3000B0	E S. CT BT STAINLESS STEEL HANDLE COVE	1	PZ																																																		
0H6575A1	XB89- XV EXTERNAL GLASS HOLDING PROFILE	2	PZ																																																		
0H7321A0	MM STAINLESS STEEL HANDLE COVE	1	PZ																																																		
CR1085A0	INTERNAL GLASS UPPER HINGE	1	PZ																																																		
CR1086A0	INTERNAL GLASS LOWER HINGE	1	PZ																																																		
ED1072A0		1	PZ																																																		
GN1181A0	INTERNAL GLASS HINGE SEAL	2	PZ																																																		
RC1200A0	ED=4 WIRE D.=0.5 COMPRESSIO N SPRING	8	PZ																																																		
SL1110A0	BIADHESIVE PIN 3M VHB 9473-PC	1	PZ																																																		
TB2384B0	BAKERLUX CHEFLUX DOOR UPPER LISTEL	1	PZ																																																		
TB2385A0	BL CL 89- RIGHT DOOR COLUMN 50X50X1.2	1	PZ																																																		



COMPONENT			SPARE PART																																																																						
Code	Description	Image	Code	Description	Components list																																																																				
VM1977A	CL BL DOOR UPPER FULCRUM-CAP		KDR1254A	XB893 XV893 COMPLETE DOOR	<table border="1"> <thead> <tr> <th>Code</th> <th>Description</th> <th>Qty</th> <th>UOM</th> </tr> </thead> <tbody> <tr> <td>TB2386A0</td> <td>BL CL 89- LEFT DOOR COLUMN 50X50X1.2</td> <td>1</td> <td>PZ</td> </tr> <tr> <td>TB2404A0</td> <td>BAKERLUX CHEFLUX DOOR LOWER LISTEL</td> <td>1</td> <td>PZ</td> </tr> <tr> <td>VI0239A1</td> <td>SELF-TAPPIN G SCREW 4.2X25 TCB+ INOX</td> <td>4</td> <td>PZ</td> </tr> <tr> <td>VI1070A0</td> <td>SCREW M4X16 TSP/UNI7688 INOX</td> <td>1</td> <td>PZ</td> </tr> <tr> <td>VI1075A0</td> <td>NUT M4 H=4 UNI5587 INOX</td> <td>1</td> <td>PZ</td> </tr> <tr> <td>VI1220A1</td> <td>4.2X12 TCB SELF-TAPPIN G SCREW</td> <td>28</td> <td>PZ</td> </tr> <tr> <td>VI1300A0</td> <td>SCREW M6X12 T1/2T+INOX</td> <td>12</td> <td>PZ</td> </tr> <tr> <td>VI1310A0</td> <td>ZINC THREAD INSERT M6 FTR/E</td> <td>8</td> <td>PZ</td> </tr> <tr> <td>VI1340A0</td> <td>M6 ST. STEEL THREADED INSERT</td> <td>4</td> <td>PZ</td> </tr> <tr> <td>VI1810A0</td> <td>M6X6 STAINLESS STEEL FLATHEAD SCREW</td> <td>6</td> <td>PZ</td> </tr> <tr> <td>VM1180B0</td> <td>CHEFTOP/BAK ERTOP HANDLE SHAF</td> <td>1</td> <td>PZ</td> </tr> <tr> <td>VM1181B0</td> <td>E SERIES CT BT HANDLE SHAFT CAP</td> <td>1</td> <td>PZ</td> </tr> <tr> <td>VM1182B0</td> <td>E S. CT BT HANDLE JUNCTION + PIN GUIDE</td> <td>1</td> <td>PZ</td> </tr> <tr> <td>VM1182B1</td> <td>E S. CT BT HANDLE JUNCTION + PIN GUIDE</td> <td>1</td> <td>PZ</td> </tr> <tr> <td>VM1183A1</td> <td>CHEFTOP/BAK ERTOP HANDLE PIN</td> <td>1</td> <td>PZ</td> </tr> <tr> <td>VM1183B0</td> <td>CHEFTOP/BAK ERTOP HANDLE PIN</td> <td>1</td> <td>PZ</td> </tr> </tbody> </table>	Code	Description	Qty	UOM	TB2386A0	BL CL 89- LEFT DOOR COLUMN 50X50X1.2	1	PZ	TB2404A0	BAKERLUX CHEFLUX DOOR LOWER LISTEL	1	PZ	VI0239A1	SELF-TAPPIN G SCREW 4.2X25 TCB+ INOX	4	PZ	VI1070A0	SCREW M4X16 TSP/UNI7688 INOX	1	PZ	VI1075A0	NUT M4 H=4 UNI5587 INOX	1	PZ	VI1220A1	4.2X12 TCB SELF-TAPPIN G SCREW	28	PZ	VI1300A0	SCREW M6X12 T1/2T+INOX	12	PZ	VI1310A0	ZINC THREAD INSERT M6 FTR/E	8	PZ	VI1340A0	M6 ST. STEEL THREADED INSERT	4	PZ	VI1810A0	M6X6 STAINLESS STEEL FLATHEAD SCREW	6	PZ	VM1180B0	CHEFTOP/BAK ERTOP HANDLE SHAF	1	PZ	VM1181B0	E SERIES CT BT HANDLE SHAFT CAP	1	PZ	VM1182B0	E S. CT BT HANDLE JUNCTION + PIN GUIDE	1	PZ	VM1182B1	E S. CT BT HANDLE JUNCTION + PIN GUIDE	1	PZ	VM1183A1	CHEFTOP/BAK ERTOP HANDLE PIN	1	PZ	VM1183B0	CHEFTOP/BAK ERTOP HANDLE PIN	1	PZ
Code	Description	Qty	UOM																																																																						
TB2386A0	BL CL 89- LEFT DOOR COLUMN 50X50X1.2	1	PZ																																																																						
TB2404A0	BAKERLUX CHEFLUX DOOR LOWER LISTEL	1	PZ																																																																						
VI0239A1	SELF-TAPPIN G SCREW 4.2X25 TCB+ INOX	4	PZ																																																																						
VI1070A0	SCREW M4X16 TSP/UNI7688 INOX	1	PZ																																																																						
VI1075A0	NUT M4 H=4 UNI5587 INOX	1	PZ																																																																						
VI1220A1	4.2X12 TCB SELF-TAPPIN G SCREW	28	PZ																																																																						
VI1300A0	SCREW M6X12 T1/2T+INOX	12	PZ																																																																						
VI1310A0	ZINC THREAD INSERT M6 FTR/E	8	PZ																																																																						
VI1340A0	M6 ST. STEEL THREADED INSERT	4	PZ																																																																						
VI1810A0	M6X6 STAINLESS STEEL FLATHEAD SCREW	6	PZ																																																																						
VM1180B0	CHEFTOP/BAK ERTOP HANDLE SHAF	1	PZ																																																																						
VM1181B0	E SERIES CT BT HANDLE SHAFT CAP	1	PZ																																																																						
VM1182B0	E S. CT BT HANDLE JUNCTION + PIN GUIDE	1	PZ																																																																						
VM1182B1	E S. CT BT HANDLE JUNCTION + PIN GUIDE	1	PZ																																																																						
VM1183A1	CHEFTOP/BAK ERTOP HANDLE PIN	1	PZ																																																																						
VM1183B0	CHEFTOP/BAK ERTOP HANDLE PIN	1	PZ																																																																						



COMPONENT			SPARE PART																																																																														
Code	Description	Image	Code	Description	Components list																																																																												
VM1977A	CL BL DOOR UPPER FULCRUM-CAP		KDR1254A	XB893 XV893 COMPLETE DOOR	<table border="1"> <thead> <tr> <th>Code</th> <th>Description</th> <th>Qty</th> <th>UOM</th> </tr> </thead> <tbody> <tr> <td>VM1490A0</td> <td>CHEFTOP/BAK ERTOP HANDLE SCREWS COVER</td> <td>2</td> <td>PZ</td> </tr> <tr> <td>VM1510A0</td> <td>XBC/XVC GROOVED DOOR PIN BUSHING</td> <td>1</td> <td>PZ</td> </tr> <tr> <td>VM1511A0</td> <td>XBC/XVC SLEEK DOOR PIN BUSHING</td> <td>1</td> <td>PZ</td> </tr> <tr> <td>VM1591A0</td> <td>GLASS BRACKET INT. XVC1004</td> <td>1</td> <td>PZ</td> </tr> <tr> <td>VM1630A0</td> <td>INTERNAL GLASS PUSHING CAP</td> <td>2</td> <td>PZ</td> </tr> <tr> <td>VM1680A0</td> <td>INTERNAL GLASS HINGE</td> <td>2</td> <td>PZ</td> </tr> <tr> <td>VM1695A0</td> <td>HANDLE POSITION PIN</td> <td>4</td> <td>PZ</td> </tr> <tr> <td>VM1976A0</td> <td>CL BL DOOR COLUMN BLANKING CA</td> <td>2</td> <td>PZ</td> </tr> <tr> <td>VM1977A0</td> <td>CL BL DOOR UPPER FULCRUM-CA</td> <td>1</td> <td>PZ</td> </tr> <tr> <td>VM1978A0</td> <td>CL BL DOOR LOWER FULCRUM-CA</td> <td>1</td> <td>PZ</td> </tr> <tr> <td>VM2000A0</td> <td>M4 SOCKET HEAD SCREW COVER</td> <td>6</td> <td>PZ</td> </tr> <tr> <td>VM2008A0</td> <td>SPACER FOR MICROSWITC</td> <td>1</td> <td>PZ</td> </tr> <tr> <td>VM2042A0</td> <td>INTERNAL GLASS LATERAL LOCKING SYSTEM</td> <td>2</td> <td>PZ</td> </tr> <tr> <td>VM2043A0</td> <td>UPPER - LOWER GLASS SUPPORT</td> <td>2</td> <td>PZ</td> </tr> <tr> <td>VM2245A0</td> <td>HANDLE SHAFT WITH LATCH</td> <td>1</td> <td>PZ</td> </tr> <tr> <td>VM2247A0</td> <td>HANDLE SHAFT COVER VM2245-2246</td> <td>1</td> <td>PZ</td> </tr> <tr> <td>VT1140A0</td> <td>XB893/895 XBC804/805 INTERNAL GLASS</td> <td>1</td> <td>PZ</td> </tr> <tr> <td>VT1254A0</td> <td>OUTER GLASS XB89- XC89-</td> <td>1</td> <td>PZ</td> </tr> </tbody> </table>	Code	Description	Qty	UOM	VM1490A0	CHEFTOP/BAK ERTOP HANDLE SCREWS COVER	2	PZ	VM1510A0	XBC/XVC GROOVED DOOR PIN BUSHING	1	PZ	VM1511A0	XBC/XVC SLEEK DOOR PIN BUSHING	1	PZ	VM1591A0	GLASS BRACKET INT. XVC1004	1	PZ	VM1630A0	INTERNAL GLASS PUSHING CAP	2	PZ	VM1680A0	INTERNAL GLASS HINGE	2	PZ	VM1695A0	HANDLE POSITION PIN	4	PZ	VM1976A0	CL BL DOOR COLUMN BLANKING CA	2	PZ	VM1977A0	CL BL DOOR UPPER FULCRUM-CA	1	PZ	VM1978A0	CL BL DOOR LOWER FULCRUM-CA	1	PZ	VM2000A0	M4 SOCKET HEAD SCREW COVER	6	PZ	VM2008A0	SPACER FOR MICROSWITC	1	PZ	VM2042A0	INTERNAL GLASS LATERAL LOCKING SYSTEM	2	PZ	VM2043A0	UPPER - LOWER GLASS SUPPORT	2	PZ	VM2245A0	HANDLE SHAFT WITH LATCH	1	PZ	VM2247A0	HANDLE SHAFT COVER VM2245-2246	1	PZ	VT1140A0	XB893/895 XBC804/805 INTERNAL GLASS	1	PZ	VT1254A0	OUTER GLASS XB89- XC89-	1	PZ
Code	Description	Qty	UOM																																																																														
VM1490A0	CHEFTOP/BAK ERTOP HANDLE SCREWS COVER	2	PZ																																																																														
VM1510A0	XBC/XVC GROOVED DOOR PIN BUSHING	1	PZ																																																																														
VM1511A0	XBC/XVC SLEEK DOOR PIN BUSHING	1	PZ																																																																														
VM1591A0	GLASS BRACKET INT. XVC1004	1	PZ																																																																														
VM1630A0	INTERNAL GLASS PUSHING CAP	2	PZ																																																																														
VM1680A0	INTERNAL GLASS HINGE	2	PZ																																																																														
VM1695A0	HANDLE POSITION PIN	4	PZ																																																																														
VM1976A0	CL BL DOOR COLUMN BLANKING CA	2	PZ																																																																														
VM1977A0	CL BL DOOR UPPER FULCRUM-CA	1	PZ																																																																														
VM1978A0	CL BL DOOR LOWER FULCRUM-CA	1	PZ																																																																														
VM2000A0	M4 SOCKET HEAD SCREW COVER	6	PZ																																																																														
VM2008A0	SPACER FOR MICROSWITC	1	PZ																																																																														
VM2042A0	INTERNAL GLASS LATERAL LOCKING SYSTEM	2	PZ																																																																														
VM2043A0	UPPER - LOWER GLASS SUPPORT	2	PZ																																																																														
VM2245A0	HANDLE SHAFT WITH LATCH	1	PZ																																																																														
VM2247A0	HANDLE SHAFT COVER VM2245-2246	1	PZ																																																																														
VT1140A0	XB893/895 XBC804/805 INTERNAL GLASS	1	PZ																																																																														
VT1254A0	OUTER GLASS XB89- XC89-	1	PZ																																																																														





COMPONENT			SPARE PART																																																																						
Code	Description	Image	Code	Description	Components list																																																																				
VM1978A	CL BL DOOR LOWER FULCRUM-CAP		KDR1254A	XB893 XV893 COMPLETE DOOR	<table border="1"> <thead> <tr> <th>Code</th> <th>Description</th> <th>Qty</th> <th>UOM</th> </tr> </thead> <tbody> <tr> <td>0H3000B0</td> <td>E S. CT BT STAINLESS STEEL HANDLE COVE</td> <td>1</td> <td>PZ</td> </tr> <tr> <td>0H6575A1</td> <td>XB89- XV EXTERNAL GLASS HOLDING PROFILE</td> <td>2</td> <td>PZ</td> </tr> <tr> <td>0H7321A0</td> <td>MM STAINLESS STEEL HANDLE COVE</td> <td>1</td> <td>PZ</td> </tr> <tr> <td>CR1085A0</td> <td>INTERNAL GLASS UPPER HINGE</td> <td>1</td> <td>PZ</td> </tr> <tr> <td>CR1086A0</td> <td>INTERNAL GLASS LOWER HINGE</td> <td>1</td> <td>PZ</td> </tr> <tr> <td>ED1072A0</td> <td></td> <td>1</td> <td>PZ</td> </tr> <tr> <td>GN1181A0</td> <td>INTERNAL GLASS HINGE SEAL</td> <td>2</td> <td>PZ</td> </tr> <tr> <td>RC1200A0</td> <td>ED=4 WIRE D.=0.5 COMPRESSIO N SPRING</td> <td>8</td> <td>PZ</td> </tr> <tr> <td>SL1110A0</td> <td>BIADHESIVE PIN 3M VHB 9473-PC</td> <td>1</td> <td>PZ</td> </tr> <tr> <td>TB2384B0</td> <td>BAKERLUX CHEFLUX DOOR UPPER LISTEL</td> <td>1</td> <td>PZ</td> </tr> <tr> <td>TB2385A0</td> <td>BL CL 89- RIGHT DOOR COLUMN 50X50X1.2</td> <td>1</td> <td>PZ</td> </tr> <tr> <td>TB2386A0</td> <td>BL CL 89- LEFT DOOR COLUMN 50X50X1.2</td> <td>1</td> <td>PZ</td> </tr> <tr> <td>TB2404A0</td> <td>BAKERLUX CHEFLUX DOOR LOWER LISTEL</td> <td>1</td> <td>PZ</td> </tr> <tr> <td>VI0239A1</td> <td>SELF-TAPPIN G SCREW 4.2X25 TCB+ INOX</td> <td>4</td> <td>PZ</td> </tr> <tr> <td>VI1070A0</td> <td>SCREW M4X16 TSP/UNI7688 INOX</td> <td>1</td> <td>PZ</td> </tr> <tr> <td>VI1075A0</td> <td>NUT M4 H=4 UNI5587 INOX</td> <td>1</td> <td>PZ</td> </tr> </tbody> </table>	Code	Description	Qty	UOM	0H3000B0	E S. CT BT STAINLESS STEEL HANDLE COVE	1	PZ	0H6575A1	XB89- XV EXTERNAL GLASS HOLDING PROFILE	2	PZ	0H7321A0	MM STAINLESS STEEL HANDLE COVE	1	PZ	CR1085A0	INTERNAL GLASS UPPER HINGE	1	PZ	CR1086A0	INTERNAL GLASS LOWER HINGE	1	PZ	ED1072A0		1	PZ	GN1181A0	INTERNAL GLASS HINGE SEAL	2	PZ	RC1200A0	ED=4 WIRE D.=0.5 COMPRESSIO N SPRING	8	PZ	SL1110A0	BIADHESIVE PIN 3M VHB 9473-PC	1	PZ	TB2384B0	BAKERLUX CHEFLUX DOOR UPPER LISTEL	1	PZ	TB2385A0	BL CL 89- RIGHT DOOR COLUMN 50X50X1.2	1	PZ	TB2386A0	BL CL 89- LEFT DOOR COLUMN 50X50X1.2	1	PZ	TB2404A0	BAKERLUX CHEFLUX DOOR LOWER LISTEL	1	PZ	VI0239A1	SELF-TAPPIN G SCREW 4.2X25 TCB+ INOX	4	PZ	VI1070A0	SCREW M4X16 TSP/UNI7688 INOX	1	PZ	VI1075A0	NUT M4 H=4 UNI5587 INOX	1	PZ
Code	Description	Qty	UOM																																																																						
0H3000B0	E S. CT BT STAINLESS STEEL HANDLE COVE	1	PZ																																																																						
0H6575A1	XB89- XV EXTERNAL GLASS HOLDING PROFILE	2	PZ																																																																						
0H7321A0	MM STAINLESS STEEL HANDLE COVE	1	PZ																																																																						
CR1085A0	INTERNAL GLASS UPPER HINGE	1	PZ																																																																						
CR1086A0	INTERNAL GLASS LOWER HINGE	1	PZ																																																																						
ED1072A0		1	PZ																																																																						
GN1181A0	INTERNAL GLASS HINGE SEAL	2	PZ																																																																						
RC1200A0	ED=4 WIRE D.=0.5 COMPRESSIO N SPRING	8	PZ																																																																						
SL1110A0	BIADHESIVE PIN 3M VHB 9473-PC	1	PZ																																																																						
TB2384B0	BAKERLUX CHEFLUX DOOR UPPER LISTEL	1	PZ																																																																						
TB2385A0	BL CL 89- RIGHT DOOR COLUMN 50X50X1.2	1	PZ																																																																						
TB2386A0	BL CL 89- LEFT DOOR COLUMN 50X50X1.2	1	PZ																																																																						
TB2404A0	BAKERLUX CHEFLUX DOOR LOWER LISTEL	1	PZ																																																																						
VI0239A1	SELF-TAPPIN G SCREW 4.2X25 TCB+ INOX	4	PZ																																																																						
VI1070A0	SCREW M4X16 TSP/UNI7688 INOX	1	PZ																																																																						
VI1075A0	NUT M4 H=4 UNI5587 INOX	1	PZ																																																																						



COMPONENT			SPARE PART																																																																						
Code	Description	Image	Code	Description	Components list																																																																				
VM1978A	CL BL DOOR LOWER FULCRUM-CAP		KDR1254A	XB893 XV893 COMPLETE DOOR	<table border="1"> <thead> <tr> <th>Code</th> <th>Description</th> <th>Qty</th> <th>UOM</th> </tr> </thead> <tbody> <tr> <td>VI1220A1</td> <td>4,2X12 TCB SELF-TAPPIN G SCREW</td> <td>28</td> <td>PZ</td> </tr> <tr> <td>VI1300A0</td> <td>SCREW M6X12 T1/2T+INOX</td> <td>12</td> <td>PZ</td> </tr> <tr> <td>VI1310A0</td> <td>ZINC THREAD INSERT M6 FTR/E</td> <td>8</td> <td>PZ</td> </tr> <tr> <td>VI1340A0</td> <td>M6 ST. STEEL THREADED INSERT</td> <td>4</td> <td>PZ</td> </tr> <tr> <td>VI1810A0</td> <td>M6X6 STAINLESS STEEL FLATHEAD SCREW</td> <td>6</td> <td>PZ</td> </tr> <tr> <td>VM1180B0</td> <td>CHEFTOP/BAK ERTOP HANDLE SHAF</td> <td>1</td> <td>PZ</td> </tr> <tr> <td>VM1181B0</td> <td>E SERIES CT BT HANDLE SHAFT CAP</td> <td>1</td> <td>PZ</td> </tr> <tr> <td>VM1182B0</td> <td>E S. CT BT HANDLE JUNCTION + PIN GUIDE</td> <td>1</td> <td>PZ</td> </tr> <tr> <td>VM1182B1</td> <td>E S. CT BT HANDLE JUNCTION + PIN GUIDE</td> <td>1</td> <td>PZ</td> </tr> <tr> <td>VM1183A1</td> <td>CHEFTOP/BAK ERTOP HANDLE PIN</td> <td>1</td> <td>PZ</td> </tr> <tr> <td>VM1183B0</td> <td>CHEFTOP/BAK ERTOP HANDLE PIN</td> <td>1</td> <td>PZ</td> </tr> <tr> <td>VM1490A0</td> <td>CHEFTOP/BAK ERTOP HANDLE SCREWS COVER</td> <td>2</td> <td>PZ</td> </tr> <tr> <td>VM1510A0</td> <td>XBC/XVC GROOVED DOOR PIN BUSHING</td> <td>1</td> <td>PZ</td> </tr> <tr> <td>VM1511A0</td> <td>XBC/XVC SLEEK DOOR PIN BUSHING</td> <td>1</td> <td>PZ</td> </tr> <tr> <td>VM1591A0</td> <td>GLASS BRACKET INT. XVC1004</td> <td>1</td> <td>PZ</td> </tr> <tr> <td>VM1630A0</td> <td>INTERNAL GLASS PUSHING CAP</td> <td>2</td> <td>PZ</td> </tr> </tbody> </table>	Code	Description	Qty	UOM	VI1220A1	4,2X12 TCB SELF-TAPPIN G SCREW	28	PZ	VI1300A0	SCREW M6X12 T1/2T+INOX	12	PZ	VI1310A0	ZINC THREAD INSERT M6 FTR/E	8	PZ	VI1340A0	M6 ST. STEEL THREADED INSERT	4	PZ	VI1810A0	M6X6 STAINLESS STEEL FLATHEAD SCREW	6	PZ	VM1180B0	CHEFTOP/BAK ERTOP HANDLE SHAF	1	PZ	VM1181B0	E SERIES CT BT HANDLE SHAFT CAP	1	PZ	VM1182B0	E S. CT BT HANDLE JUNCTION + PIN GUIDE	1	PZ	VM1182B1	E S. CT BT HANDLE JUNCTION + PIN GUIDE	1	PZ	VM1183A1	CHEFTOP/BAK ERTOP HANDLE PIN	1	PZ	VM1183B0	CHEFTOP/BAK ERTOP HANDLE PIN	1	PZ	VM1490A0	CHEFTOP/BAK ERTOP HANDLE SCREWS COVER	2	PZ	VM1510A0	XBC/XVC GROOVED DOOR PIN BUSHING	1	PZ	VM1511A0	XBC/XVC SLEEK DOOR PIN BUSHING	1	PZ	VM1591A0	GLASS BRACKET INT. XVC1004	1	PZ	VM1630A0	INTERNAL GLASS PUSHING CAP	2	PZ
Code	Description	Qty	UOM																																																																						
VI1220A1	4,2X12 TCB SELF-TAPPIN G SCREW	28	PZ																																																																						
VI1300A0	SCREW M6X12 T1/2T+INOX	12	PZ																																																																						
VI1310A0	ZINC THREAD INSERT M6 FTR/E	8	PZ																																																																						
VI1340A0	M6 ST. STEEL THREADED INSERT	4	PZ																																																																						
VI1810A0	M6X6 STAINLESS STEEL FLATHEAD SCREW	6	PZ																																																																						
VM1180B0	CHEFTOP/BAK ERTOP HANDLE SHAF	1	PZ																																																																						
VM1181B0	E SERIES CT BT HANDLE SHAFT CAP	1	PZ																																																																						
VM1182B0	E S. CT BT HANDLE JUNCTION + PIN GUIDE	1	PZ																																																																						
VM1182B1	E S. CT BT HANDLE JUNCTION + PIN GUIDE	1	PZ																																																																						
VM1183A1	CHEFTOP/BAK ERTOP HANDLE PIN	1	PZ																																																																						
VM1183B0	CHEFTOP/BAK ERTOP HANDLE PIN	1	PZ																																																																						
VM1490A0	CHEFTOP/BAK ERTOP HANDLE SCREWS COVER	2	PZ																																																																						
VM1510A0	XBC/XVC GROOVED DOOR PIN BUSHING	1	PZ																																																																						
VM1511A0	XBC/XVC SLEEK DOOR PIN BUSHING	1	PZ																																																																						
VM1591A0	GLASS BRACKET INT. XVC1004	1	PZ																																																																						
VM1630A0	INTERNAL GLASS PUSHING CAP	2	PZ																																																																						



COMPONENT			SPARE PART																																																										
Code	Description	Image	Code	Description	Components list																																																								
VM1978A	CL BL DOOR LOWER FULCRUM-CAP		KDR1254A	XB893 XV893 COMPLETE DOOR	<table border="1"> <thead> <tr> <th>Code</th> <th>Description</th> <th>Qty</th> <th>UOM</th> </tr> </thead> <tbody> <tr> <td>VM1680A0</td> <td>INTERNAL GLASS HINGE</td> <td>2</td> <td>PZ</td> </tr> <tr> <td>VM1695A0</td> <td>HANDLE POSITION PIN</td> <td>4</td> <td>PZ</td> </tr> <tr> <td>VM1976A0</td> <td>CL BL DOOR COLUMN BLANKING CA</td> <td>2</td> <td>PZ</td> </tr> <tr> <td>VM1977A0</td> <td>CL BL DOOR UPPER FULCRUM-CA</td> <td>1</td> <td>PZ</td> </tr> <tr> <td>VM1978A0</td> <td>CL BL DOOR LOWER FULCRUM-CA</td> <td>1</td> <td>PZ</td> </tr> <tr> <td>VM2000A0</td> <td>M4 SOCKET HEAD SCREW COVER</td> <td>6</td> <td>PZ</td> </tr> <tr> <td>VM2008A0</td> <td>SPACER FOR MICROSWITC</td> <td>1</td> <td>PZ</td> </tr> <tr> <td>VM2042A0</td> <td>INTERNAL GLASS LATERAL LOCKING SYSTEM</td> <td>2</td> <td>PZ</td> </tr> <tr> <td>VM2043A0</td> <td>UPPER - LOWER GLASS SUPPORT</td> <td>2</td> <td>PZ</td> </tr> <tr> <td>VM2245A0</td> <td>HANDLE SHAFT WITH LATCH</td> <td>1</td> <td>PZ</td> </tr> <tr> <td>VM2247A0</td> <td>HANDLE SHAFT COVER VM2245-2246</td> <td>1</td> <td>PZ</td> </tr> <tr> <td>VT1140A0</td> <td>XB893/895 XBC804/805 INTERNAL GLASS</td> <td>1</td> <td>PZ</td> </tr> <tr> <td>VT1254A0</td> <td>OUTER GLASS XB89- XC89-</td> <td>1</td> <td>PZ</td> </tr> </tbody> </table>	Code	Description	Qty	UOM	VM1680A0	INTERNAL GLASS HINGE	2	PZ	VM1695A0	HANDLE POSITION PIN	4	PZ	VM1976A0	CL BL DOOR COLUMN BLANKING CA	2	PZ	VM1977A0	CL BL DOOR UPPER FULCRUM-CA	1	PZ	VM1978A0	CL BL DOOR LOWER FULCRUM-CA	1	PZ	VM2000A0	M4 SOCKET HEAD SCREW COVER	6	PZ	VM2008A0	SPACER FOR MICROSWITC	1	PZ	VM2042A0	INTERNAL GLASS LATERAL LOCKING SYSTEM	2	PZ	VM2043A0	UPPER - LOWER GLASS SUPPORT	2	PZ	VM2245A0	HANDLE SHAFT WITH LATCH	1	PZ	VM2247A0	HANDLE SHAFT COVER VM2245-2246	1	PZ	VT1140A0	XB893/895 XBC804/805 INTERNAL GLASS	1	PZ	VT1254A0	OUTER GLASS XB89- XC89-	1	PZ
					Code	Description	Qty	UOM																																																					
					VM1680A0	INTERNAL GLASS HINGE	2	PZ																																																					
					VM1695A0	HANDLE POSITION PIN	4	PZ																																																					
					VM1976A0	CL BL DOOR COLUMN BLANKING CA	2	PZ																																																					
					VM1977A0	CL BL DOOR UPPER FULCRUM-CA	1	PZ																																																					
					VM1978A0	CL BL DOOR LOWER FULCRUM-CA	1	PZ																																																					
					VM2000A0	M4 SOCKET HEAD SCREW COVER	6	PZ																																																					
					VM2008A0	SPACER FOR MICROSWITC	1	PZ																																																					
					VM2042A0	INTERNAL GLASS LATERAL LOCKING SYSTEM	2	PZ																																																					
					VM2043A0	UPPER - LOWER GLASS SUPPORT	2	PZ																																																					
					VM2245A0	HANDLE SHAFT WITH LATCH	1	PZ																																																					
					VM2247A0	HANDLE SHAFT COVER VM2245-2246	1	PZ																																																					
					VT1140A0	XB893/895 XBC804/805 INTERNAL GLASS	1	PZ																																																					
VT1254A0	OUTER GLASS XB89- XC89-	1	PZ																																																										
VM1976A	CL BL DOOR COLUMN BLANKING CAP		KVM1976A	CL BL DOOR COLUMN BLANKING CAP KIT	<table border="1"> <thead> <tr> <th>Code</th> <th>Description</th> <th>Qty</th> <th>UOM</th> </tr> </thead> <tbody> <tr> <td>VM1976A0</td> <td>CL BL DOOR COLUMN BLANKING CA</td> <td>1</td> <td>PZ</td> </tr> </tbody> </table>	Code	Description	Qty	UOM	VM1976A0	CL BL DOOR COLUMN BLANKING CA	1	PZ																																																
			Code	Description	Qty	UOM																																																							
VM1976A0	CL BL DOOR COLUMN BLANKING CA	1	PZ																																																										
KDR1254A	XB893 XV893 COMPLETE DOOR	<table border="1"> <thead> <tr> <th>Code</th> <th>Description</th> <th>Qty</th> <th>UOM</th> </tr> </thead> <tbody> <tr> <td>0H3000B0</td> <td>E S. CT BT STAINLESS STEEL HANDLE COVE</td> <td>1</td> <td>PZ</td> </tr> </tbody> </table>	Code	Description	Qty	UOM	0H3000B0	E S. CT BT STAINLESS STEEL HANDLE COVE	1	PZ																																																			
Code	Description	Qty	UOM																																																										
0H3000B0	E S. CT BT STAINLESS STEEL HANDLE COVE	1	PZ																																																										

COMPONENT			SPARE PART																																																																						
Code	Description	Image	Code	Description	Components list																																																																				
VM1976A	CL BL DOOR COLUMN BLANKING CAP		KDR1254A	XB893 XV893 COMPLETE DOOR	<table border="1"> <thead> <tr> <th>Code</th> <th>Description</th> <th>Qty</th> <th>UOM</th> </tr> </thead> <tbody> <tr> <td>0H6575A1</td> <td>XB89- XV EXTERNAL GLASS HOLDING PROFILE</td> <td>2</td> <td>PZ</td> </tr> <tr> <td>0H7321A0</td> <td>MM STAINLESS STEEL HANDLE COVE</td> <td>1</td> <td>PZ</td> </tr> <tr> <td>CR1085A0</td> <td>INTERNAL GLASS UPPER HINGE</td> <td>1</td> <td>PZ</td> </tr> <tr> <td>CR1086A0</td> <td>INTERNAL GLASS LOWER HINGE</td> <td>1</td> <td>PZ</td> </tr> <tr> <td>ED1072A0</td> <td></td> <td>1</td> <td>PZ</td> </tr> <tr> <td>GN1181A0</td> <td>INTERNAL GLASS HINGE SEAL</td> <td>2</td> <td>PZ</td> </tr> <tr> <td>RC1200A0</td> <td>ED=4 WIRE D.=0.5 COMPRESSIO N SPRING</td> <td>8</td> <td>PZ</td> </tr> <tr> <td>SL1110A0</td> <td>BIADHESIVE PIN 3M VHB 9473-PC</td> <td>1</td> <td>PZ</td> </tr> <tr> <td>TB2384B0</td> <td>BAKERLUX CHEFLUX DOOR UPPER LISTEL</td> <td>1</td> <td>PZ</td> </tr> <tr> <td>TB2385A0</td> <td>BL CL 89- RIGHT DOOR COLUMN 50X50X1.2</td> <td>1</td> <td>PZ</td> </tr> <tr> <td>TB2386A0</td> <td>BL CL 89- LEFT DOOR COLUMN 50X50X1.2</td> <td>1</td> <td>PZ</td> </tr> <tr> <td>TB2404A0</td> <td>BAKERLUX CHEFLUX DOOR LOWER LISTEL</td> <td>1</td> <td>PZ</td> </tr> <tr> <td>VI0239A1</td> <td>SELF-TAPPIN G SCREW 4.2X25 TCB+ INOX</td> <td>4</td> <td>PZ</td> </tr> <tr> <td>VI1070A0</td> <td>SCREW M4X16 TSP/UNI7688 INOX</td> <td>1</td> <td>PZ</td> </tr> <tr> <td>VI1075A0</td> <td>NUT M4 H=4 UNI5587 INOX</td> <td>1</td> <td>PZ</td> </tr> <tr> <td>VI1220A1</td> <td>4,2X12 TCB SELF-TAPPIN G SCREW</td> <td>28</td> <td>PZ</td> </tr> </tbody> </table>	Code	Description	Qty	UOM	0H6575A1	XB89- XV EXTERNAL GLASS HOLDING PROFILE	2	PZ	0H7321A0	MM STAINLESS STEEL HANDLE COVE	1	PZ	CR1085A0	INTERNAL GLASS UPPER HINGE	1	PZ	CR1086A0	INTERNAL GLASS LOWER HINGE	1	PZ	ED1072A0		1	PZ	GN1181A0	INTERNAL GLASS HINGE SEAL	2	PZ	RC1200A0	ED=4 WIRE D.=0.5 COMPRESSIO N SPRING	8	PZ	SL1110A0	BIADHESIVE PIN 3M VHB 9473-PC	1	PZ	TB2384B0	BAKERLUX CHEFLUX DOOR UPPER LISTEL	1	PZ	TB2385A0	BL CL 89- RIGHT DOOR COLUMN 50X50X1.2	1	PZ	TB2386A0	BL CL 89- LEFT DOOR COLUMN 50X50X1.2	1	PZ	TB2404A0	BAKERLUX CHEFLUX DOOR LOWER LISTEL	1	PZ	VI0239A1	SELF-TAPPIN G SCREW 4.2X25 TCB+ INOX	4	PZ	VI1070A0	SCREW M4X16 TSP/UNI7688 INOX	1	PZ	VI1075A0	NUT M4 H=4 UNI5587 INOX	1	PZ	VI1220A1	4,2X12 TCB SELF-TAPPIN G SCREW	28	PZ
Code	Description	Qty	UOM																																																																						
0H6575A1	XB89- XV EXTERNAL GLASS HOLDING PROFILE	2	PZ																																																																						
0H7321A0	MM STAINLESS STEEL HANDLE COVE	1	PZ																																																																						
CR1085A0	INTERNAL GLASS UPPER HINGE	1	PZ																																																																						
CR1086A0	INTERNAL GLASS LOWER HINGE	1	PZ																																																																						
ED1072A0		1	PZ																																																																						
GN1181A0	INTERNAL GLASS HINGE SEAL	2	PZ																																																																						
RC1200A0	ED=4 WIRE D.=0.5 COMPRESSIO N SPRING	8	PZ																																																																						
SL1110A0	BIADHESIVE PIN 3M VHB 9473-PC	1	PZ																																																																						
TB2384B0	BAKERLUX CHEFLUX DOOR UPPER LISTEL	1	PZ																																																																						
TB2385A0	BL CL 89- RIGHT DOOR COLUMN 50X50X1.2	1	PZ																																																																						
TB2386A0	BL CL 89- LEFT DOOR COLUMN 50X50X1.2	1	PZ																																																																						
TB2404A0	BAKERLUX CHEFLUX DOOR LOWER LISTEL	1	PZ																																																																						
VI0239A1	SELF-TAPPIN G SCREW 4.2X25 TCB+ INOX	4	PZ																																																																						
VI1070A0	SCREW M4X16 TSP/UNI7688 INOX	1	PZ																																																																						
VI1075A0	NUT M4 H=4 UNI5587 INOX	1	PZ																																																																						
VI1220A1	4,2X12 TCB SELF-TAPPIN G SCREW	28	PZ																																																																						





COMPONENT			SPARE PART																																																																										
Code	Description	Image	Code	Description	Components list																																																																								
VM1976A	CL BL DOOR COLUMN BLANKING CAP		KDR1254A	XB893 XV893 COMPLETE DOOR	<table border="1"> <thead> <tr> <th>Code</th> <th>Description</th> <th>Qty</th> <th>UOM</th> </tr> </thead> <tbody> <tr> <td>VI1300A0</td> <td>SCREW M6X12 T1/2T+INOX</td> <td>12</td> <td>PZ</td> </tr> <tr> <td>VI1310A0</td> <td>ZINC THREAD INSERT M6 FTR/E</td> <td>8</td> <td>PZ</td> </tr> <tr> <td>VI1340A0</td> <td>M6 ST. STEEL THREADED INSERT</td> <td>4</td> <td>PZ</td> </tr> <tr> <td>VI1810A0</td> <td>M6X6 STAINLESS STEEL FLATHEAD SCREW</td> <td>6</td> <td>PZ</td> </tr> <tr> <td>VM1180B0</td> <td>CHEFTOP/BAK ERTOP HANDLE SHAF</td> <td>1</td> <td>PZ</td> </tr> <tr> <td>VM1181B0</td> <td>E SERIES CT BT HANDLE SHAFT CAP</td> <td>1</td> <td>PZ</td> </tr> <tr> <td>VM1182B0</td> <td>E.S. CT BT HANDLE JUNCTION + PIN GUIDE</td> <td>1</td> <td>PZ</td> </tr> <tr> <td>VM1182B1</td> <td>E.S. CT BT HANDLE JUNCTION + PIN GUIDE</td> <td>1</td> <td>PZ</td> </tr> <tr> <td>VM1183A1</td> <td>CHEFTOP/BAK ERTOP HANDLE PIN</td> <td>1</td> <td>PZ</td> </tr> <tr> <td>VM1183B0</td> <td>CHEFTOP/BAK ERTOP HANDLE PIN</td> <td>1</td> <td>PZ</td> </tr> <tr> <td>VM1490A0</td> <td>CHEFTOP/BAK ERTOP HANDLE SCREWS COVER</td> <td>2</td> <td>PZ</td> </tr> <tr> <td>VM1510A0</td> <td>XBC/XVC GROOVED DOOR PIN BUSHING</td> <td>1</td> <td>PZ</td> </tr> <tr> <td>VM1511A0</td> <td>XBC/XVC SLEEK DOOR PIN BUSHING</td> <td>1</td> <td>PZ</td> </tr> <tr> <td>VM1591A0</td> <td>GLASS BRACKET INT. XVC1004</td> <td>1</td> <td>PZ</td> </tr> <tr> <td>VM1630A0</td> <td>INTERNAL GLASS PUSHING CAP</td> <td>2</td> <td>PZ</td> </tr> <tr> <td>VM1680A0</td> <td>INTERNAL GLASS HINGE</td> <td>2</td> <td>PZ</td> </tr> <tr> <td>VM1695A0</td> <td>HANDLE POSITION PIN</td> <td>4</td> <td>PZ</td> </tr> </tbody> </table>	Code	Description	Qty	UOM	VI1300A0	SCREW M6X12 T1/2T+INOX	12	PZ	VI1310A0	ZINC THREAD INSERT M6 FTR/E	8	PZ	VI1340A0	M6 ST. STEEL THREADED INSERT	4	PZ	VI1810A0	M6X6 STAINLESS STEEL FLATHEAD SCREW	6	PZ	VM1180B0	CHEFTOP/BAK ERTOP HANDLE SHAF	1	PZ	VM1181B0	E SERIES CT BT HANDLE SHAFT CAP	1	PZ	VM1182B0	E.S. CT BT HANDLE JUNCTION + PIN GUIDE	1	PZ	VM1182B1	E.S. CT BT HANDLE JUNCTION + PIN GUIDE	1	PZ	VM1183A1	CHEFTOP/BAK ERTOP HANDLE PIN	1	PZ	VM1183B0	CHEFTOP/BAK ERTOP HANDLE PIN	1	PZ	VM1490A0	CHEFTOP/BAK ERTOP HANDLE SCREWS COVER	2	PZ	VM1510A0	XBC/XVC GROOVED DOOR PIN BUSHING	1	PZ	VM1511A0	XBC/XVC SLEEK DOOR PIN BUSHING	1	PZ	VM1591A0	GLASS BRACKET INT. XVC1004	1	PZ	VM1630A0	INTERNAL GLASS PUSHING CAP	2	PZ	VM1680A0	INTERNAL GLASS HINGE	2	PZ	VM1695A0	HANDLE POSITION PIN	4	PZ
Code	Description	Qty	UOM																																																																										
VI1300A0	SCREW M6X12 T1/2T+INOX	12	PZ																																																																										
VI1310A0	ZINC THREAD INSERT M6 FTR/E	8	PZ																																																																										
VI1340A0	M6 ST. STEEL THREADED INSERT	4	PZ																																																																										
VI1810A0	M6X6 STAINLESS STEEL FLATHEAD SCREW	6	PZ																																																																										
VM1180B0	CHEFTOP/BAK ERTOP HANDLE SHAF	1	PZ																																																																										
VM1181B0	E SERIES CT BT HANDLE SHAFT CAP	1	PZ																																																																										
VM1182B0	E.S. CT BT HANDLE JUNCTION + PIN GUIDE	1	PZ																																																																										
VM1182B1	E.S. CT BT HANDLE JUNCTION + PIN GUIDE	1	PZ																																																																										
VM1183A1	CHEFTOP/BAK ERTOP HANDLE PIN	1	PZ																																																																										
VM1183B0	CHEFTOP/BAK ERTOP HANDLE PIN	1	PZ																																																																										
VM1490A0	CHEFTOP/BAK ERTOP HANDLE SCREWS COVER	2	PZ																																																																										
VM1510A0	XBC/XVC GROOVED DOOR PIN BUSHING	1	PZ																																																																										
VM1511A0	XBC/XVC SLEEK DOOR PIN BUSHING	1	PZ																																																																										
VM1591A0	GLASS BRACKET INT. XVC1004	1	PZ																																																																										
VM1630A0	INTERNAL GLASS PUSHING CAP	2	PZ																																																																										
VM1680A0	INTERNAL GLASS HINGE	2	PZ																																																																										
VM1695A0	HANDLE POSITION PIN	4	PZ																																																																										



COMPONENT			SPARE PART																																																		
Code	Description	Image	Code	Description	Components list																																																
VM1976A	CL BL DOOR COLUMN BLANKING CAP		KDR1254A	XB893 XV893 COMPLETE DOOR	<table border="1"> <thead> <tr> <th>Code</th> <th>Description</th> <th>Qty</th> <th>UOM</th> </tr> </thead> <tbody> <tr> <td>VM1976A0</td> <td>CL BL DOOR COLUMN BLANKING CA</td> <td>2</td> <td>PZ</td> </tr> <tr> <td>VM1977A0</td> <td>CL BL DOOR UPPER FULCRUM-CA</td> <td>1</td> <td>PZ</td> </tr> <tr> <td>VM1978A0</td> <td>CL BL DOOR LOWER FULCRUM-CA</td> <td>1</td> <td>PZ</td> </tr> <tr> <td>VM2000A0</td> <td>M4 SOCKET HEAD SCREW COVER</td> <td>6</td> <td>PZ</td> </tr> <tr> <td>VM2008A0</td> <td>SPACER FOR MICROSWITC</td> <td>1</td> <td>PZ</td> </tr> <tr> <td>VM2042A0</td> <td>INTERNAL GLASS LATERAL LOCKING SYSTEM</td> <td>2</td> <td>PZ</td> </tr> <tr> <td>VM2043A0</td> <td>UPPER - LOWER GLASS SUPPORT</td> <td>2</td> <td>PZ</td> </tr> <tr> <td>VM2245A0</td> <td>HANDLE SHAFT WITH LATCH</td> <td>1</td> <td>PZ</td> </tr> <tr> <td>VM2247A0</td> <td>HANDLE SHAFT COVER VM2245-2246</td> <td>1</td> <td>PZ</td> </tr> <tr> <td>VT1140A0</td> <td>XB893/895 XBC804/805 INTERNAL GLASS</td> <td>1</td> <td>PZ</td> </tr> <tr> <td>VT1254A0</td> <td>OUTER GLASS XB89- XC89-</td> <td>1</td> <td>PZ</td> </tr> </tbody> </table>	Code	Description	Qty	UOM	VM1976A0	CL BL DOOR COLUMN BLANKING CA	2	PZ	VM1977A0	CL BL DOOR UPPER FULCRUM-CA	1	PZ	VM1978A0	CL BL DOOR LOWER FULCRUM-CA	1	PZ	VM2000A0	M4 SOCKET HEAD SCREW COVER	6	PZ	VM2008A0	SPACER FOR MICROSWITC	1	PZ	VM2042A0	INTERNAL GLASS LATERAL LOCKING SYSTEM	2	PZ	VM2043A0	UPPER - LOWER GLASS SUPPORT	2	PZ	VM2245A0	HANDLE SHAFT WITH LATCH	1	PZ	VM2247A0	HANDLE SHAFT COVER VM2245-2246	1	PZ	VT1140A0	XB893/895 XBC804/805 INTERNAL GLASS	1	PZ	VT1254A0	OUTER GLASS XB89- XC89-	1	PZ
Code	Description	Qty	UOM																																																		
VM1976A0	CL BL DOOR COLUMN BLANKING CA	2	PZ																																																		
VM1977A0	CL BL DOOR UPPER FULCRUM-CA	1	PZ																																																		
VM1978A0	CL BL DOOR LOWER FULCRUM-CA	1	PZ																																																		
VM2000A0	M4 SOCKET HEAD SCREW COVER	6	PZ																																																		
VM2008A0	SPACER FOR MICROSWITC	1	PZ																																																		
VM2042A0	INTERNAL GLASS LATERAL LOCKING SYSTEM	2	PZ																																																		
VM2043A0	UPPER - LOWER GLASS SUPPORT	2	PZ																																																		
VM2245A0	HANDLE SHAFT WITH LATCH	1	PZ																																																		
VM2247A0	HANDLE SHAFT COVER VM2245-2246	1	PZ																																																		
VT1140A0	XB893/895 XBC804/805 INTERNAL GLASS	1	PZ																																																		
VT1254A0	OUTER GLASS XB89- XC89-	1	PZ																																																		
VM1680A	INTERNAL GLASS HINGE		KVM1680A	INTERNAL GLASS HINGE SUPPORT KI	<table border="1"> <thead> <tr> <th>Code</th> <th>Description</th> <th>Qty</th> <th>UOM</th> </tr> </thead> <tbody> <tr> <td>VM1680A0</td> <td>INTERNAL GLASS HINGE</td> <td>2</td> <td>PZ</td> </tr> </tbody> </table>	Code	Description	Qty	UOM	VM1680A0	INTERNAL GLASS HINGE	2	PZ																																								
Code	Description	Qty	UOM																																																		
VM1680A0	INTERNAL GLASS HINGE	2	PZ																																																		

COMPONENT			SPARE PART																										
Code	Description	Image	Code	Description	Components list																								
VM2043A	UPPER - LOWER GLASS SUPPORT		KVM2043A	UPPER - LOWER GLASS SUPPORT 2 PCS KIT	<table border="1"> <thead> <tr> <th>Code</th> <th>Description</th> <th>Qty</th> <th>UOM</th> </tr> </thead> <tbody> <tr> <td>VM2043A0</td> <td>UPPER - LOWER GLASS SUPPORT</td> <td>2</td> <td>PZ</td> </tr> </tbody> </table>	Code	Description	Qty	UOM	VM2043A0	UPPER - LOWER GLASS SUPPORT	2	PZ																
Code	Description	Qty	UOM																										
VM2043A0	UPPER - LOWER GLASS SUPPORT	2	PZ																										
VE1030A	MAGNET FOR DOOR MICROSWITCH D=22,9MM		KVE1030A	2 PCS MAGNET KIT FOR DOOR SWITCH	<table border="1"> <thead> <tr> <th>Code</th> <th>Description</th> <th>Qty</th> <th>UOM</th> </tr> </thead> <tbody> <tr> <td>VE1030A1</td> <td>MAGNET FOR DOOR MICROSWITC H D=22,9MM</td> <td>2</td> <td>PZ</td> </tr> </tbody> </table>	Code	Description	Qty	UOM	VE1030A1	MAGNET FOR DOOR MICROSWITC H D=22,9MM	2	PZ																
Code	Description	Qty	UOM																										
VE1030A1	MAGNET FOR DOOR MICROSWITC H D=22,9MM	2	PZ																										
			KVE1020A	MICROSWITCH KIT	<table border="1"> <thead> <tr> <th>Code</th> <th>Description</th> <th>Qty</th> <th>UOM</th> </tr> </thead> <tbody> <tr> <td>VE1020A2</td> <td>MAGNETIC DOOR MICROSWITC</td> <td>1</td> <td>PZ</td> </tr> <tr> <td>VE1030A1</td> <td>MAGNET FOR DOOR MICROSWITC H D=22,9MM</td> <td>4</td> <td>PZ</td> </tr> </tbody> </table>	Code	Description	Qty	UOM	VE1020A2	MAGNETIC DOOR MICROSWITC	1	PZ	VE1030A1	MAGNET FOR DOOR MICROSWITC H D=22,9MM	4	PZ												
Code	Description	Qty	UOM																										
VE1020A2	MAGNETIC DOOR MICROSWITC	1	PZ																										
VE1030A1	MAGNET FOR DOOR MICROSWITC H D=22,9MM	4	PZ																										
VM2042A	INTERNAL GLASS LATERAL LOCKING SYSTEM		KVM2042A	INTERNAL GLASS SPRING STOPPER KIT	<table border="1"> <thead> <tr> <th>Code</th> <th>Description</th> <th>Qty</th> <th>UOM</th> </tr> </thead> <tbody> <tr> <td>RC1200A0</td> <td>ED=4 WIRE D.=0.5 COMPRESSIO N SPRING</td> <td>2</td> <td>PZ</td> </tr> <tr> <td>VI1220A1</td> <td>4,2X12 TCB SELF-TAPPIN G SCREW</td> <td>2</td> <td>PZ</td> </tr> <tr> <td>VM2042A0</td> <td>INTERNAL GLASS LATERAL LOCKING SYSTEM</td> <td>1</td> <td>PZ</td> </tr> </tbody> </table>	Code	Description	Qty	UOM	RC1200A0	ED=4 WIRE D.=0.5 COMPRESSIO N SPRING	2	PZ	VI1220A1	4,2X12 TCB SELF-TAPPIN G SCREW	2	PZ	VM2042A0	INTERNAL GLASS LATERAL LOCKING SYSTEM	1	PZ								
Code	Description	Qty	UOM																										
RC1200A0	ED=4 WIRE D.=0.5 COMPRESSIO N SPRING	2	PZ																										
VI1220A1	4,2X12 TCB SELF-TAPPIN G SCREW	2	PZ																										
VM2042A0	INTERNAL GLASS LATERAL LOCKING SYSTEM	1	PZ																										
VM1620A	LED BAR LOWER SUPPORT		KLP1007A	L200 LED BAR KIT	<table border="1"> <thead> <tr> <th>Code</th> <th>Description</th> <th>Qty</th> <th>UOM</th> </tr> </thead> <tbody> <tr> <td>CE1455A0</td> <td>TIP END FITTING</td> <td>2</td> <td>PZ</td> </tr> <tr> <td>CE1730A0</td> <td>PVC CABLE NP 2 X AWG22 STYLE 2095</td> <td>4.500</td> <td>M</td> </tr> <tr> <td>CE1735A0</td> <td>MINIFIT FEMALE END FITTING</td> <td>2</td> <td>PZ</td> </tr> <tr> <td>CE1740A0</td> <td>MINIFIT MALE END FITTING</td> <td>4</td> <td>PZ</td> </tr> <tr> <td>CE1745A0</td> <td>2 WAYS FEMALE MINIFIT CONNECTOR</td> <td>2</td> <td>PZ</td> </tr> </tbody> </table>	Code	Description	Qty	UOM	CE1455A0	TIP END FITTING	2	PZ	CE1730A0	PVC CABLE NP 2 X AWG22 STYLE 2095	4.500	M	CE1735A0	MINIFIT FEMALE END FITTING	2	PZ	CE1740A0	MINIFIT MALE END FITTING	4	PZ	CE1745A0	2 WAYS FEMALE MINIFIT CONNECTOR	2	PZ
Code	Description	Qty	UOM																										
CE1455A0	TIP END FITTING	2	PZ																										
CE1730A0	PVC CABLE NP 2 X AWG22 STYLE 2095	4.500	M																										
CE1735A0	MINIFIT FEMALE END FITTING	2	PZ																										
CE1740A0	MINIFIT MALE END FITTING	4	PZ																										
CE1745A0	2 WAYS FEMALE MINIFIT CONNECTOR	2	PZ																										

COMPONENT			SPARE PART																																																			
Code	Description	Image	Code	Description	Components list																																																	
VM1620A	LED BAR LOWER SUPPORT		KLP1007A	L200 LED BAR KIT	<table border="1"> <thead> <tr> <th>Code</th> <th>Description</th> <th>Qty</th> <th>UOM</th> </tr> </thead> <tbody> <tr> <td>CE1750A0</td> <td>3 WAYS MALE MINIFIT CONNECTOR</td> <td>1</td> <td>PZ</td> </tr> <tr> <td>LP1007A0</td> <td>LED LIGHT BAR L200</td> <td>1</td> <td>PZ</td> </tr> <tr> <td>VM1620A0</td> <td>LED BAR LOWER SUPPORT</td> <td>1</td> <td>PZ</td> </tr> <tr> <td>VM1621A0</td> <td>LED BAR UPPER SUPPORT</td> <td>1</td> <td>PZ</td> </tr> </tbody> </table>	Code	Description	Qty	UOM	CE1750A0	3 WAYS MALE MINIFIT CONNECTOR	1	PZ	LP1007A0	LED LIGHT BAR L200	1	PZ	VM1620A0	LED BAR LOWER SUPPORT	1	PZ	VM1621A0	LED BAR UPPER SUPPORT	1	PZ																													
			Code	Description	Qty	UOM																																																
			CE1750A0	3 WAYS MALE MINIFIT CONNECTOR	1	PZ																																																
LP1007A0	LED LIGHT BAR L200	1	PZ																																																			
VM1620A0	LED BAR LOWER SUPPORT	1	PZ																																																			
VM1621A0	LED BAR UPPER SUPPORT	1	PZ																																																			
KLP1004B	L1000 LED BAR KIT	<table border="1"> <thead> <tr> <th>Code</th> <th>Description</th> <th>Qty</th> <th>UOM</th> </tr> </thead> <tbody> <tr> <td>CE1730A0</td> <td>PVC CABLE NP 2 X AWG22 STYLE 2095</td> <td>1</td> <td>M</td> </tr> <tr> <td>CE1735A0</td> <td>MINIFIT FEMALE END FITTING</td> <td>2</td> <td>PZ</td> </tr> <tr> <td>CE1740A0</td> <td>MINIFIT MALE END FITTING</td> <td>2</td> <td>PZ</td> </tr> <tr> <td>CE1745A0</td> <td>2 WAYS FEMALE MINIFIT CONNECTOR</td> <td>1</td> <td>PZ</td> </tr> <tr> <td>CE1750A0</td> <td>3 WAYS MALE MINIFIT CONNECTOR</td> <td>1</td> <td>PZ</td> </tr> <tr> <td>IP1385A1</td> <td>CORNER POLYSTYREN E PACKING 110X80X2000</td> <td>2.200</td> <td>M</td> </tr> <tr> <td>LP1004B0</td> <td>LEB LIGHTING BAR L1000</td> <td>1</td> <td>PZ</td> </tr> <tr> <td>VM1059A1</td> <td>HEAT SHRINK FILM H800</td> <td>1.300</td> <td>M</td> </tr> <tr> <td>VM1620A0</td> <td>LED BAR LOWER SUPPORT</td> <td>1</td> <td>PZ</td> </tr> <tr> <td>VM1621A0</td> <td>LED BAR UPPER SUPPORT</td> <td>1</td> <td>PZ</td> </tr> <tr> <td>VM1794A0</td> <td>250X4.8 PA66 BLACK CLAMP</td> <td>2</td> <td>PZ</td> </tr> <tr> <td>VM2103A0</td> <td>CLAMP LOCK</td> <td>2</td> <td>PZ</td> </tr> </tbody> </table>	Code	Description	Qty	UOM	CE1730A0	PVC CABLE NP 2 X AWG22 STYLE 2095	1	M	CE1735A0	MINIFIT FEMALE END FITTING	2	PZ	CE1740A0	MINIFIT MALE END FITTING	2	PZ	CE1745A0	2 WAYS FEMALE MINIFIT CONNECTOR	1	PZ	CE1750A0	3 WAYS MALE MINIFIT CONNECTOR	1	PZ	IP1385A1	CORNER POLYSTYREN E PACKING 110X80X2000	2.200	M	LP1004B0	LEB LIGHTING BAR L1000	1	PZ	VM1059A1	HEAT SHRINK FILM H800	1.300	M	VM1620A0	LED BAR LOWER SUPPORT	1	PZ	VM1621A0	LED BAR UPPER SUPPORT	1	PZ	VM1794A0	250X4.8 PA66 BLACK CLAMP	2	PZ	VM2103A0	CLAMP LOCK	2	PZ
Code	Description	Qty	UOM																																																			
CE1730A0	PVC CABLE NP 2 X AWG22 STYLE 2095	1	M																																																			
CE1735A0	MINIFIT FEMALE END FITTING	2	PZ																																																			
CE1740A0	MINIFIT MALE END FITTING	2	PZ																																																			
CE1745A0	2 WAYS FEMALE MINIFIT CONNECTOR	1	PZ																																																			
CE1750A0	3 WAYS MALE MINIFIT CONNECTOR	1	PZ																																																			
IP1385A1	CORNER POLYSTYREN E PACKING 110X80X2000	2.200	M																																																			
LP1004B0	LEB LIGHTING BAR L1000	1	PZ																																																			
VM1059A1	HEAT SHRINK FILM H800	1.300	M																																																			
VM1620A0	LED BAR LOWER SUPPORT	1	PZ																																																			
VM1621A0	LED BAR UPPER SUPPORT	1	PZ																																																			
VM1794A0	250X4.8 PA66 BLACK CLAMP	2	PZ																																																			
VM2103A0	CLAMP LOCK	2	PZ																																																			
KLP1003B	2017 LED BAR KIT	<table border="1"> <thead> <tr> <th>Code</th> <th>Description</th> <th>Qty</th> <th>UOM</th> </tr> </thead> <tbody> <tr> <td>CE1730A0</td> <td>PVC CABLE NP 2 X AWG22 STYLE 2095</td> <td>1</td> <td>M</td> </tr> <tr> <td>CE1735A0</td> <td>MINIFIT FEMALE END FITTING</td> <td>2</td> <td>PZ</td> </tr> <tr> <td>CE1740A0</td> <td>MINIFIT MALE END FITTING</td> <td>2</td> <td>PZ</td> </tr> </tbody> </table>	Code	Description	Qty	UOM	CE1730A0	PVC CABLE NP 2 X AWG22 STYLE 2095	1	M	CE1735A0	MINIFIT FEMALE END FITTING	2	PZ	CE1740A0	MINIFIT MALE END FITTING	2	PZ																																				
Code	Description	Qty	UOM																																																			
CE1730A0	PVC CABLE NP 2 X AWG22 STYLE 2095	1	M																																																			
CE1735A0	MINIFIT FEMALE END FITTING	2	PZ																																																			
CE1740A0	MINIFIT MALE END FITTING	2	PZ																																																			



COMPONENT			SPARE PART																																															
Code	Description	Image	Code	Description	Components list																																													
VM1620A	LED BAR LOWER SUPPORT		KLP1003B	2017 LED BAR KIT	<table border="1"> <thead> <tr> <th>Code</th> <th>Description</th> <th>Qty</th> <th>UOM</th> </tr> </thead> <tbody> <tr> <td>CE1745A0</td> <td>2 WAYS FEMALE MINIFIT CONNECTOR</td> <td>1</td> <td>PZ</td> </tr> <tr> <td>CE1750A0</td> <td>3 WAYS MALE MINIFIT CONNECTOR</td> <td>1</td> <td>PZ</td> </tr> <tr> <td>LP1003B0</td> <td>LED LIGHT BAR L600</td> <td>1</td> <td>PZ</td> </tr> <tr> <td>VM1620A0</td> <td>LED BAR LOWER SUPPORT</td> <td>1</td> <td>PZ</td> </tr> <tr> <td>VM1621A0</td> <td>LED BAR UPPER SUPPORT</td> <td>1</td> <td>PZ</td> </tr> <tr> <td>VM1794A0</td> <td>250X4.8 PA66 BLACK CLAMP</td> <td>2</td> <td>PZ</td> </tr> <tr> <td>VM2103A0</td> <td>CLAMP LOCK</td> <td>2</td> <td>PZ</td> </tr> </tbody> </table>	Code	Description	Qty	UOM	CE1745A0	2 WAYS FEMALE MINIFIT CONNECTOR	1	PZ	CE1750A0	3 WAYS MALE MINIFIT CONNECTOR	1	PZ	LP1003B0	LED LIGHT BAR L600	1	PZ	VM1620A0	LED BAR LOWER SUPPORT	1	PZ	VM1621A0	LED BAR UPPER SUPPORT	1	PZ	VM1794A0	250X4.8 PA66 BLACK CLAMP	2	PZ	VM2103A0	CLAMP LOCK	2	PZ													
			Code	Description	Qty	UOM																																												
			CE1745A0	2 WAYS FEMALE MINIFIT CONNECTOR	1	PZ																																												
CE1750A0	3 WAYS MALE MINIFIT CONNECTOR	1	PZ																																															
LP1003B0	LED LIGHT BAR L600	1	PZ																																															
VM1620A0	LED BAR LOWER SUPPORT	1	PZ																																															
VM1621A0	LED BAR UPPER SUPPORT	1	PZ																																															
VM1794A0	250X4.8 PA66 BLACK CLAMP	2	PZ																																															
VM2103A0	CLAMP LOCK	2	PZ																																															
KLP1002B	L400 LED BAR KIT	<table border="1"> <thead> <tr> <th>Code</th> <th>Description</th> <th>Qty</th> <th>UOM</th> </tr> </thead> <tbody> <tr> <td>CE1455A0</td> <td>TIP END FITTING</td> <td>2</td> <td>PZ</td> </tr> <tr> <td>CE1730A0</td> <td>PVC CABLE NP 2 X AWG22 STYLE 2095</td> <td>4.500</td> <td>M</td> </tr> <tr> <td>CE1735A0</td> <td>MINIFIT FEMALE END FITTING</td> <td>2</td> <td>PZ</td> </tr> <tr> <td>CE1740A0</td> <td>MINIFIT MALE END FITTING</td> <td>4</td> <td>PZ</td> </tr> <tr> <td>CE1745A0</td> <td>2 WAYS FEMALE MINIFIT CONNECTOR</td> <td>2</td> <td>PZ</td> </tr> <tr> <td>CE1750A0</td> <td>3 WAYS MALE MINIFIT CONNECTOR</td> <td>1</td> <td>PZ</td> </tr> <tr> <td>LP1002B0</td> <td>LED LIGHTING BAR L400</td> <td>1</td> <td>PZ</td> </tr> <tr> <td>VM1620A0</td> <td>LED BAR LOWER SUPPORT</td> <td>1</td> <td>PZ</td> </tr> <tr> <td>VM1621A0</td> <td>LED BAR UPPER SUPPORT</td> <td>1</td> <td>PZ</td> </tr> <tr> <td>VM1794A0</td> <td>250X4.8 PA66 BLACK CLAMP</td> <td>2</td> <td>PZ</td> </tr> <tr> <td>VM2103A0</td> <td>CLAMP LOCK</td> <td>2</td> <td>PZ</td> </tr> </tbody> </table>	Code	Description	Qty	UOM	CE1455A0	TIP END FITTING	2	PZ	CE1730A0	PVC CABLE NP 2 X AWG22 STYLE 2095	4.500	M	CE1735A0	MINIFIT FEMALE END FITTING	2	PZ	CE1740A0	MINIFIT MALE END FITTING	4	PZ	CE1745A0	2 WAYS FEMALE MINIFIT CONNECTOR	2	PZ	CE1750A0	3 WAYS MALE MINIFIT CONNECTOR	1	PZ	LP1002B0	LED LIGHTING BAR L400	1	PZ	VM1620A0	LED BAR LOWER SUPPORT	1	PZ	VM1621A0	LED BAR UPPER SUPPORT	1	PZ	VM1794A0	250X4.8 PA66 BLACK CLAMP	2	PZ	VM2103A0	CLAMP LOCK	2	PZ
Code	Description	Qty	UOM																																															
CE1455A0	TIP END FITTING	2	PZ																																															
CE1730A0	PVC CABLE NP 2 X AWG22 STYLE 2095	4.500	M																																															
CE1735A0	MINIFIT FEMALE END FITTING	2	PZ																																															
CE1740A0	MINIFIT MALE END FITTING	4	PZ																																															
CE1745A0	2 WAYS FEMALE MINIFIT CONNECTOR	2	PZ																																															
CE1750A0	3 WAYS MALE MINIFIT CONNECTOR	1	PZ																																															
LP1002B0	LED LIGHTING BAR L400	1	PZ																																															
VM1620A0	LED BAR LOWER SUPPORT	1	PZ																																															
VM1621A0	LED BAR UPPER SUPPORT	1	PZ																																															
VM1794A0	250X4.8 PA66 BLACK CLAMP	2	PZ																																															
VM2103A0	CLAMP LOCK	2	PZ																																															
KLP1001B	L300 LED BAR KIT	<table border="1"> <thead> <tr> <th>Code</th> <th>Description</th> <th>Qty</th> <th>UOM</th> </tr> </thead> <tbody> <tr> <td>CE1455A0</td> <td>TIP END FITTING</td> <td>2</td> <td>PZ</td> </tr> <tr> <td>CE1730A0</td> <td>PVC CABLE NP 2 X AWG22 STYLE 2095</td> <td>4.500</td> <td>M</td> </tr> </tbody> </table>	Code	Description	Qty	UOM	CE1455A0	TIP END FITTING	2	PZ	CE1730A0	PVC CABLE NP 2 X AWG22 STYLE 2095	4.500	M																																				
Code	Description	Qty	UOM																																															
CE1455A0	TIP END FITTING	2	PZ																																															
CE1730A0	PVC CABLE NP 2 X AWG22 STYLE 2095	4.500	M																																															



COMPONENT			SPARE PART																																										
Code	Description	Image	Code	Description	Components list																																								
VM1620A	LED BAR LOWER SUPPORT		KLP1001B	L300 LED BAR KIT	<table border="1"> <thead> <tr> <th>Code</th> <th>Description</th> <th>Qty</th> <th>UOM</th> </tr> </thead> <tbody> <tr> <td>CE1735A0</td> <td>MINIFIT FEMALE END FITTING</td> <td>2</td> <td>PZ</td> </tr> <tr> <td>CE1740A0</td> <td>MINIFIT MALE END FITTING</td> <td>4</td> <td>PZ</td> </tr> <tr> <td>CE1745A0</td> <td>2 WAYS FEMALE MINIFIT CONNECTOR</td> <td>2</td> <td>PZ</td> </tr> <tr> <td>CE1750A0</td> <td>3 WAYS MALE MINIFIT CONNECTOR</td> <td>1</td> <td>PZ</td> </tr> <tr> <td>LP1001B0</td> <td>LED LIGHTING BAR L300</td> <td>1</td> <td>PZ</td> </tr> <tr> <td>VM1620A0</td> <td>LED BAR LOWER SUPPORT</td> <td>1</td> <td>PZ</td> </tr> <tr> <td>VM1621A0</td> <td>LED BAR UPPER SUPPORT</td> <td>1</td> <td>PZ</td> </tr> </tbody> </table>	Code	Description	Qty	UOM	CE1735A0	MINIFIT FEMALE END FITTING	2	PZ	CE1740A0	MINIFIT MALE END FITTING	4	PZ	CE1745A0	2 WAYS FEMALE MINIFIT CONNECTOR	2	PZ	CE1750A0	3 WAYS MALE MINIFIT CONNECTOR	1	PZ	LP1001B0	LED LIGHTING BAR L300	1	PZ	VM1620A0	LED BAR LOWER SUPPORT	1	PZ	VM1621A0	LED BAR UPPER SUPPORT	1	PZ								
			Code	Description	Qty	UOM																																							
CE1735A0	MINIFIT FEMALE END FITTING	2	PZ																																										
CE1740A0	MINIFIT MALE END FITTING	4	PZ																																										
CE1745A0	2 WAYS FEMALE MINIFIT CONNECTOR	2	PZ																																										
CE1750A0	3 WAYS MALE MINIFIT CONNECTOR	1	PZ																																										
LP1001B0	LED LIGHTING BAR L300	1	PZ																																										
VM1620A0	LED BAR LOWER SUPPORT	1	PZ																																										
VM1621A0	LED BAR UPPER SUPPORT	1	PZ																																										
KLP1000A	L100 LED BAR KIT	<table border="1"> <thead> <tr> <th>Code</th> <th>Description</th> <th>Qty</th> <th>UOM</th> </tr> </thead> <tbody> <tr> <td>LP1000A0</td> <td>LED LIGHTING BAR L100</td> <td>1</td> <td>PZ</td> </tr> <tr> <td>VM1620A0</td> <td>LED BAR LOWER SUPPORT</td> <td>1</td> <td>PZ</td> </tr> <tr> <td>VM1621A0</td> <td>LED BAR UPPER SUPPORT</td> <td>1</td> <td>PZ</td> </tr> </tbody> </table>	Code	Description	Qty	UOM	LP1000A0	LED LIGHTING BAR L100	1	PZ	VM1620A0	LED BAR LOWER SUPPORT	1	PZ	VM1621A0	LED BAR UPPER SUPPORT	1	PZ																											
Code	Description	Qty	UOM																																										
LP1000A0	LED LIGHTING BAR L100	1	PZ																																										
VM1620A0	LED BAR LOWER SUPPORT	1	PZ																																										
VM1621A0	LED BAR UPPER SUPPORT	1	PZ																																										
VM1621A	LED BAR UPPER SUPPORT		KLP1007A	L200 LED BAR KIT	<table border="1"> <thead> <tr> <th>Code</th> <th>Description</th> <th>Qty</th> <th>UOM</th> </tr> </thead> <tbody> <tr> <td>CE1455A0</td> <td>TIP END FITTING</td> <td>2</td> <td>PZ</td> </tr> <tr> <td>CE1730A0</td> <td>PVC CABLE NP 2 X AWG22 STYLE 2095</td> <td>4.500</td> <td>M</td> </tr> <tr> <td>CE1735A0</td> <td>MINIFIT FEMALE END FITTING</td> <td>2</td> <td>PZ</td> </tr> <tr> <td>CE1740A0</td> <td>MINIFIT MALE END FITTING</td> <td>4</td> <td>PZ</td> </tr> <tr> <td>CE1745A0</td> <td>2 WAYS FEMALE MINIFIT CONNECTOR</td> <td>2</td> <td>PZ</td> </tr> <tr> <td>CE1750A0</td> <td>3 WAYS MALE MINIFIT CONNECTOR</td> <td>1</td> <td>PZ</td> </tr> <tr> <td>LP1007A0</td> <td>LED LIGHT BAR L200</td> <td>1</td> <td>PZ</td> </tr> <tr> <td>VM1620A0</td> <td>LED BAR LOWER SUPPORT</td> <td>1</td> <td>PZ</td> </tr> <tr> <td>VM1621A0</td> <td>LED BAR UPPER SUPPORT</td> <td>1</td> <td>PZ</td> </tr> </tbody> </table>	Code	Description	Qty	UOM	CE1455A0	TIP END FITTING	2	PZ	CE1730A0	PVC CABLE NP 2 X AWG22 STYLE 2095	4.500	M	CE1735A0	MINIFIT FEMALE END FITTING	2	PZ	CE1740A0	MINIFIT MALE END FITTING	4	PZ	CE1745A0	2 WAYS FEMALE MINIFIT CONNECTOR	2	PZ	CE1750A0	3 WAYS MALE MINIFIT CONNECTOR	1	PZ	LP1007A0	LED LIGHT BAR L200	1	PZ	VM1620A0	LED BAR LOWER SUPPORT	1	PZ	VM1621A0	LED BAR UPPER SUPPORT	1	PZ
					Code	Description	Qty	UOM																																					
					CE1455A0	TIP END FITTING	2	PZ																																					
					CE1730A0	PVC CABLE NP 2 X AWG22 STYLE 2095	4.500	M																																					
					CE1735A0	MINIFIT FEMALE END FITTING	2	PZ																																					
					CE1740A0	MINIFIT MALE END FITTING	4	PZ																																					
					CE1745A0	2 WAYS FEMALE MINIFIT CONNECTOR	2	PZ																																					
					CE1750A0	3 WAYS MALE MINIFIT CONNECTOR	1	PZ																																					
					LP1007A0	LED LIGHT BAR L200	1	PZ																																					
					VM1620A0	LED BAR LOWER SUPPORT	1	PZ																																					
					VM1621A0	LED BAR UPPER SUPPORT	1	PZ																																					



COMPONENT			SPARE PART																																																																																									
Code	Description	Image	Code	Description	Components list																																																																																							
VM1621A	LED BAR UPPER SUPPORT		KLP1004B	L1000 LED BAR KIT	<table border="1"> <thead> <tr> <th>Code</th> <th>Description</th> <th>Qty</th> <th>UOM</th> </tr> </thead> <tbody> <tr> <td>CE1730A0</td> <td>PVC CABLE NP 2 X AWG22 STYLE 2095</td> <td>1</td> <td>M</td> </tr> <tr> <td>CE1735A0</td> <td>MINIFIT FEMALE END FITTING</td> <td>2</td> <td>PZ</td> </tr> <tr> <td>CE1740A0</td> <td>MINIFIT MALE END FITTING</td> <td>2</td> <td>PZ</td> </tr> <tr> <td>CE1745A0</td> <td>2 WAYS FEMALE MINIFIT CONNECTOR</td> <td>1</td> <td>PZ</td> </tr> <tr> <td>CE1750A0</td> <td>3 WAYS MALE MINIFIT CONNECTOR</td> <td>1</td> <td>PZ</td> </tr> <tr> <td>IP1385A1</td> <td>CORNER POLYSTYREN E PACKING 110X80X2000</td> <td>2.200</td> <td>M</td> </tr> <tr> <td>LP1004B0</td> <td>LEB LIGHTING BAR L1000</td> <td>1</td> <td>PZ</td> </tr> <tr> <td>VM1059A1</td> <td>HEAT SHRINK FILM H800</td> <td>1.300</td> <td>M</td> </tr> <tr> <td>VM1620A0</td> <td>LED BAR LOWER SUPPORT</td> <td>1</td> <td>PZ</td> </tr> <tr> <td>VM1621A0</td> <td>LED BAR UPPER SUPPORT</td> <td>1</td> <td>PZ</td> </tr> <tr> <td>VM1794A0</td> <td>250X4.8 PA66 BLACK CLAMP</td> <td>2</td> <td>PZ</td> </tr> <tr> <td>VM2103A0</td> <td>CLAMP LOCK</td> <td>2</td> <td>PZ</td> </tr> </tbody> </table>	Code	Description	Qty	UOM	CE1730A0	PVC CABLE NP 2 X AWG22 STYLE 2095	1	M	CE1735A0	MINIFIT FEMALE END FITTING	2	PZ	CE1740A0	MINIFIT MALE END FITTING	2	PZ	CE1745A0	2 WAYS FEMALE MINIFIT CONNECTOR	1	PZ	CE1750A0	3 WAYS MALE MINIFIT CONNECTOR	1	PZ	IP1385A1	CORNER POLYSTYREN E PACKING 110X80X2000	2.200	M	LP1004B0	LEB LIGHTING BAR L1000	1	PZ	VM1059A1	HEAT SHRINK FILM H800	1.300	M	VM1620A0	LED BAR LOWER SUPPORT	1	PZ	VM1621A0	LED BAR UPPER SUPPORT	1	PZ	VM1794A0	250X4.8 PA66 BLACK CLAMP	2	PZ	VM2103A0	CLAMP LOCK	2	PZ	KLP1003B	2017 LED BAR KIT	<table border="1"> <thead> <tr> <th>Code</th> <th>Description</th> <th>Qty</th> <th>UOM</th> </tr> </thead> <tbody> <tr> <td>CE1730A0</td> <td>PVC CABLE NP 2 X AWG22 STYLE 2095</td> <td>1</td> <td>M</td> </tr> <tr> <td>CE1735A0</td> <td>MINIFIT FEMALE END FITTING</td> <td>2</td> <td>PZ</td> </tr> <tr> <td>CE1740A0</td> <td>MINIFIT MALE END FITTING</td> <td>2</td> <td>PZ</td> </tr> <tr> <td>CE1745A0</td> <td>2 WAYS FEMALE MINIFIT CONNECTOR</td> <td>1</td> <td>PZ</td> </tr> <tr> <td>CE1750A0</td> <td>3 WAYS MALE MINIFIT CONNECTOR</td> <td>1</td> <td>PZ</td> </tr> <tr> <td>LP1003B0</td> <td>LED LIGHT BAR L600</td> <td>1</td> <td>PZ</td> </tr> <tr> <td>VM1620A0</td> <td>LED BAR LOWER SUPPORT</td> <td>1</td> <td>PZ</td> </tr> </tbody> </table>	Code	Description	Qty	UOM	CE1730A0	PVC CABLE NP 2 X AWG22 STYLE 2095	1	M	CE1735A0	MINIFIT FEMALE END FITTING	2	PZ	CE1740A0	MINIFIT MALE END FITTING	2	PZ	CE1745A0	2 WAYS FEMALE MINIFIT CONNECTOR	1	PZ	CE1750A0	3 WAYS MALE MINIFIT CONNECTOR	1	PZ	LP1003B0	LED LIGHT BAR L600	1	PZ	VM1620A0	LED BAR LOWER SUPPORT	1	PZ
			Code	Description	Qty	UOM																																																																																						
CE1730A0	PVC CABLE NP 2 X AWG22 STYLE 2095	1	M																																																																																									
CE1735A0	MINIFIT FEMALE END FITTING	2	PZ																																																																																									
CE1740A0	MINIFIT MALE END FITTING	2	PZ																																																																																									
CE1745A0	2 WAYS FEMALE MINIFIT CONNECTOR	1	PZ																																																																																									
CE1750A0	3 WAYS MALE MINIFIT CONNECTOR	1	PZ																																																																																									
IP1385A1	CORNER POLYSTYREN E PACKING 110X80X2000	2.200	M																																																																																									
LP1004B0	LEB LIGHTING BAR L1000	1	PZ																																																																																									
VM1059A1	HEAT SHRINK FILM H800	1.300	M																																																																																									
VM1620A0	LED BAR LOWER SUPPORT	1	PZ																																																																																									
VM1621A0	LED BAR UPPER SUPPORT	1	PZ																																																																																									
VM1794A0	250X4.8 PA66 BLACK CLAMP	2	PZ																																																																																									
VM2103A0	CLAMP LOCK	2	PZ																																																																																									
Code	Description	Qty	UOM																																																																																									
CE1730A0	PVC CABLE NP 2 X AWG22 STYLE 2095	1	M																																																																																									
CE1735A0	MINIFIT FEMALE END FITTING	2	PZ																																																																																									
CE1740A0	MINIFIT MALE END FITTING	2	PZ																																																																																									
CE1745A0	2 WAYS FEMALE MINIFIT CONNECTOR	1	PZ																																																																																									
CE1750A0	3 WAYS MALE MINIFIT CONNECTOR	1	PZ																																																																																									
LP1003B0	LED LIGHT BAR L600	1	PZ																																																																																									
VM1620A0	LED BAR LOWER SUPPORT	1	PZ																																																																																									

COMPONENT			SPARE PART																																															
Code	Description	Image	Code	Description	Components list																																													
VM1621A	LED BAR UPPER SUPPORT		KLP1003B	2017 LED BAR KIT	<table border="1"> <thead> <tr> <th>Code</th> <th>Description</th> <th>Qty</th> <th>UOM</th> </tr> </thead> <tbody> <tr> <td>VM1621A0</td> <td>LED BAR UPPER SUPPORT</td> <td>1</td> <td>PZ</td> </tr> <tr> <td>VM1794A0</td> <td>250X4.8 PA66 BLACK CLAMP</td> <td>2</td> <td>PZ</td> </tr> <tr> <td>VM2103A0</td> <td>CLAMP LOCK</td> <td>2</td> <td>PZ</td> </tr> </tbody> </table>	Code	Description	Qty	UOM	VM1621A0	LED BAR UPPER SUPPORT	1	PZ	VM1794A0	250X4.8 PA66 BLACK CLAMP	2	PZ	VM2103A0	CLAMP LOCK	2	PZ																													
			Code	Description	Qty	UOM																																												
			VM1621A0	LED BAR UPPER SUPPORT	1	PZ																																												
VM1794A0	250X4.8 PA66 BLACK CLAMP	2	PZ																																															
VM2103A0	CLAMP LOCK	2	PZ																																															
KLP1002B	L400 LED BAR KIT	<table border="1"> <thead> <tr> <th>Code</th> <th>Description</th> <th>Qty</th> <th>UOM</th> </tr> </thead> <tbody> <tr> <td>CE1455A0</td> <td>TIP END FITTING</td> <td>2</td> <td>PZ</td> </tr> <tr> <td>CE1730A0</td> <td>PVC CABLE NP 2 X AWG22 STYLE 2095</td> <td>4.500</td> <td>M</td> </tr> <tr> <td>CE1735A0</td> <td>MINIFIT FEMALE END FITTING</td> <td>2</td> <td>PZ</td> </tr> <tr> <td>CE1740A0</td> <td>MINIFIT MALE END FITTING</td> <td>4</td> <td>PZ</td> </tr> <tr> <td>CE1745A0</td> <td>2 WAYS FEMALE MINIFIT CONNECTOR</td> <td>2</td> <td>PZ</td> </tr> <tr> <td>CE1750A0</td> <td>3 WAYS MALE MINIFIT CONNECTOR</td> <td>1</td> <td>PZ</td> </tr> <tr> <td>LP1002B0</td> <td>LED LIGHTING BAR L400</td> <td>1</td> <td>PZ</td> </tr> <tr> <td>VM1620A0</td> <td>LED BAR LOWER SUPPORT</td> <td>1</td> <td>PZ</td> </tr> <tr> <td>VM1621A0</td> <td>LED BAR UPPER SUPPORT</td> <td>1</td> <td>PZ</td> </tr> <tr> <td>VM1794A0</td> <td>250X4.8 PA66 BLACK CLAMP</td> <td>2</td> <td>PZ</td> </tr> <tr> <td>VM2103A0</td> <td>CLAMP LOCK</td> <td>2</td> <td>PZ</td> </tr> </tbody> </table>	Code	Description	Qty	UOM	CE1455A0	TIP END FITTING	2	PZ	CE1730A0	PVC CABLE NP 2 X AWG22 STYLE 2095	4.500	M	CE1735A0	MINIFIT FEMALE END FITTING	2	PZ	CE1740A0	MINIFIT MALE END FITTING	4	PZ	CE1745A0	2 WAYS FEMALE MINIFIT CONNECTOR	2	PZ	CE1750A0	3 WAYS MALE MINIFIT CONNECTOR	1	PZ	LP1002B0	LED LIGHTING BAR L400	1	PZ	VM1620A0	LED BAR LOWER SUPPORT	1	PZ	VM1621A0	LED BAR UPPER SUPPORT	1	PZ	VM1794A0	250X4.8 PA66 BLACK CLAMP	2	PZ	VM2103A0	CLAMP LOCK	2	PZ
Code	Description	Qty	UOM																																															
CE1455A0	TIP END FITTING	2	PZ																																															
CE1730A0	PVC CABLE NP 2 X AWG22 STYLE 2095	4.500	M																																															
CE1735A0	MINIFIT FEMALE END FITTING	2	PZ																																															
CE1740A0	MINIFIT MALE END FITTING	4	PZ																																															
CE1745A0	2 WAYS FEMALE MINIFIT CONNECTOR	2	PZ																																															
CE1750A0	3 WAYS MALE MINIFIT CONNECTOR	1	PZ																																															
LP1002B0	LED LIGHTING BAR L400	1	PZ																																															
VM1620A0	LED BAR LOWER SUPPORT	1	PZ																																															
VM1621A0	LED BAR UPPER SUPPORT	1	PZ																																															
VM1794A0	250X4.8 PA66 BLACK CLAMP	2	PZ																																															
VM2103A0	CLAMP LOCK	2	PZ																																															
KLP1001B	L300 LED BAR KIT	<table border="1"> <thead> <tr> <th>Code</th> <th>Description</th> <th>Qty</th> <th>UOM</th> </tr> </thead> <tbody> <tr> <td>CE1455A0</td> <td>TIP END FITTING</td> <td>2</td> <td>PZ</td> </tr> <tr> <td>CE1730A0</td> <td>PVC CABLE NP 2 X AWG22 STYLE 2095</td> <td>4.500</td> <td>M</td> </tr> <tr> <td>CE1735A0</td> <td>MINIFIT FEMALE END FITTING</td> <td>2</td> <td>PZ</td> </tr> <tr> <td>CE1740A0</td> <td>MINIFIT MALE END FITTING</td> <td>4</td> <td>PZ</td> </tr> <tr> <td>CE1745A0</td> <td>2 WAYS FEMALE MINIFIT CONNECTOR</td> <td>2</td> <td>PZ</td> </tr> <tr> <td>CE1750A0</td> <td>3 WAYS MALE MINIFIT CONNECTOR</td> <td>1</td> <td>PZ</td> </tr> </tbody> </table>	Code	Description	Qty	UOM	CE1455A0	TIP END FITTING	2	PZ	CE1730A0	PVC CABLE NP 2 X AWG22 STYLE 2095	4.500	M	CE1735A0	MINIFIT FEMALE END FITTING	2	PZ	CE1740A0	MINIFIT MALE END FITTING	4	PZ	CE1745A0	2 WAYS FEMALE MINIFIT CONNECTOR	2	PZ	CE1750A0	3 WAYS MALE MINIFIT CONNECTOR	1	PZ																				
Code	Description	Qty	UOM																																															
CE1455A0	TIP END FITTING	2	PZ																																															
CE1730A0	PVC CABLE NP 2 X AWG22 STYLE 2095	4.500	M																																															
CE1735A0	MINIFIT FEMALE END FITTING	2	PZ																																															
CE1740A0	MINIFIT MALE END FITTING	4	PZ																																															
CE1745A0	2 WAYS FEMALE MINIFIT CONNECTOR	2	PZ																																															
CE1750A0	3 WAYS MALE MINIFIT CONNECTOR	1	PZ																																															

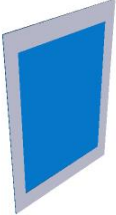

COMPONENT			SPARE PART																																										
Code	Description	Image	Code	Description	Components list																																								
VM1621A	LED BAR UPPER SUPPORT		KLP1001B	L300 LED BAR KIT	<table border="1"> <thead> <tr> <th>Code</th> <th>Description</th> <th>Qty</th> <th>UOM</th> </tr> </thead> <tbody> <tr> <td>LP1001B0</td> <td>LED LIGHTING BAR L300</td> <td>1</td> <td>PZ</td> </tr> <tr> <td>VM1620A0</td> <td>LED BAR LOWER SUPPORT</td> <td>1</td> <td>PZ</td> </tr> <tr> <td>VM1621A0</td> <td>LED BAR UPPER SUPPORT</td> <td>1</td> <td>PZ</td> </tr> </tbody> </table>	Code	Description	Qty	UOM	LP1001B0	LED LIGHTING BAR L300	1	PZ	VM1620A0	LED BAR LOWER SUPPORT	1	PZ	VM1621A0	LED BAR UPPER SUPPORT	1	PZ																								
			Code	Description	Qty	UOM																																							
LP1001B0	LED LIGHTING BAR L300	1	PZ																																										
VM1620A0	LED BAR LOWER SUPPORT	1	PZ																																										
VM1621A0	LED BAR UPPER SUPPORT	1	PZ																																										
KLP1000A	L100 LED BAR KIT	<table border="1"> <thead> <tr> <th>Code</th> <th>Description</th> <th>Qty</th> <th>UOM</th> </tr> </thead> <tbody> <tr> <td>LP1000A0</td> <td>LED LIGHTING BAR L100</td> <td>1</td> <td>PZ</td> </tr> <tr> <td>VM1620A0</td> <td>LED BAR LOWER SUPPORT</td> <td>1</td> <td>PZ</td> </tr> <tr> <td>VM1621A0</td> <td>LED BAR UPPER SUPPORT</td> <td>1</td> <td>PZ</td> </tr> </tbody> </table>	Code	Description	Qty	UOM	LP1000A0	LED LIGHTING BAR L100	1	PZ	VM1620A0	LED BAR LOWER SUPPORT	1	PZ	VM1621A0	LED BAR UPPER SUPPORT	1	PZ																											
Code	Description	Qty	UOM																																										
LP1000A0	LED LIGHTING BAR L100	1	PZ																																										
VM1620A0	LED BAR LOWER SUPPORT	1	PZ																																										
VM1621A0	LED BAR UPPER SUPPORT	1	PZ																																										
LP1044A	LUX LED BAR		KLP1044A	LUX LED BAR KIT	<table border="1"> <thead> <tr> <th>Code</th> <th>Description</th> <th>Qty</th> <th>UOM</th> </tr> </thead> <tbody> <tr> <td>CE1455A0</td> <td>TIP END FITTING</td> <td>2</td> <td>PZ</td> </tr> <tr> <td>CE1730A0</td> <td>PVC CABLE NP 2 X AWG22 STYLE 2095</td> <td>4.500</td> <td>M</td> </tr> <tr> <td>CE1735A0</td> <td>MINIFIT FEMALE END FITTING</td> <td>2</td> <td>PZ</td> </tr> <tr> <td>CE1740A0</td> <td>MINIFIT MALE END FITTING</td> <td>4</td> <td>PZ</td> </tr> <tr> <td>CE1745A0</td> <td>2 WAYS FEMALE MINIFIT CONNECTOR</td> <td>2</td> <td>PZ</td> </tr> <tr> <td>CE1750A0</td> <td>3 WAYS MALE MINIFIT CONNECTOR</td> <td>1</td> <td>PZ</td> </tr> <tr> <td>LP1044A0</td> <td>LUX LED BAR</td> <td>1</td> <td>PZ</td> </tr> <tr> <td>VM1620A0</td> <td>LED BAR LOWER SUPPORT</td> <td>1</td> <td>PZ</td> </tr> <tr> <td>VM1621A0</td> <td>LED BAR UPPER SUPPORT</td> <td>1</td> <td>PZ</td> </tr> </tbody> </table>	Code	Description	Qty	UOM	CE1455A0	TIP END FITTING	2	PZ	CE1730A0	PVC CABLE NP 2 X AWG22 STYLE 2095	4.500	M	CE1735A0	MINIFIT FEMALE END FITTING	2	PZ	CE1740A0	MINIFIT MALE END FITTING	4	PZ	CE1745A0	2 WAYS FEMALE MINIFIT CONNECTOR	2	PZ	CE1750A0	3 WAYS MALE MINIFIT CONNECTOR	1	PZ	LP1044A0	LUX LED BAR	1	PZ	VM1620A0	LED BAR LOWER SUPPORT	1	PZ	VM1621A0	LED BAR UPPER SUPPORT	1	PZ
					Code	Description	Qty	UOM																																					
					CE1455A0	TIP END FITTING	2	PZ																																					
					CE1730A0	PVC CABLE NP 2 X AWG22 STYLE 2095	4.500	M																																					
					CE1735A0	MINIFIT FEMALE END FITTING	2	PZ																																					
					CE1740A0	MINIFIT MALE END FITTING	4	PZ																																					
					CE1745A0	2 WAYS FEMALE MINIFIT CONNECTOR	2	PZ																																					
					CE1750A0	3 WAYS MALE MINIFIT CONNECTOR	1	PZ																																					
					LP1044A0	LUX LED BAR	1	PZ																																					
					VM1620A0	LED BAR LOWER SUPPORT	1	PZ																																					
VM1621A0	LED BAR UPPER SUPPORT	1	PZ																																										
TB3095A	BL CL 89 RIGHT COLUMN		TB3095A0	BL CL 89 RIGHT COLUMN																																									

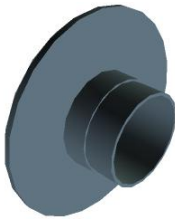

COMPONENT			SPARE PART																																		
Code	Description	Image	Code	Description	Components list																																
TB3093A	BL CL 89 LEFT COLUMN		TB3093A0	BL CL 89 LEFT COLUMN																																	
VT1254A	OUTER GLASS XB89- XC89-		KVT1254AR	XB89-XV893 LED EXTERNAL GLASS KIT	<table border="1"> <thead> <tr> <th>Code</th> <th>Description</th> <th>Qty</th> <th>UOM</th> </tr> </thead> <tbody> <tr> <td>0H7530A0</td> <td>XB89- XV EXTERNAL GLASS HOLDING PROFILE</td> <td>2</td> <td>PZ</td> </tr> <tr> <td>IP1385A1</td> <td>CORNER POLYSTYRENE PACKING 110X80X2000</td> <td>3.450</td> <td>M</td> </tr> <tr> <td>IP1508A1</td> <td>POLYSTYRENE U SHAPED PROFILE 2000X60X60</td> <td>3</td> <td>M</td> </tr> <tr> <td>SL1156A0</td> <td>NOZZLE FOR SILICON GUN</td> <td>1.200</td> <td>PZ</td> </tr> <tr> <td>VM1059A1</td> <td>HEAT SHRINK FILM H800</td> <td>1.700</td> <td>M</td> </tr> <tr> <td>VT1254A0</td> <td>OUTER GLASS XB89- XC89-</td> <td>1</td> <td>PZ</td> </tr> </tbody> </table>	Code	Description	Qty	UOM	0H7530A0	XB89- XV EXTERNAL GLASS HOLDING PROFILE	2	PZ	IP1385A1	CORNER POLYSTYRENE PACKING 110X80X2000	3.450	M	IP1508A1	POLYSTYRENE U SHAPED PROFILE 2000X60X60	3	M	SL1156A0	NOZZLE FOR SILICON GUN	1.200	PZ	VM1059A1	HEAT SHRINK FILM H800	1.700	M	VT1254A0	OUTER GLASS XB89- XC89-	1	PZ				
Code	Description	Qty	UOM																																		
0H7530A0	XB89- XV EXTERNAL GLASS HOLDING PROFILE	2	PZ																																		
IP1385A1	CORNER POLYSTYRENE PACKING 110X80X2000	3.450	M																																		
IP1508A1	POLYSTYRENE U SHAPED PROFILE 2000X60X60	3	M																																		
SL1156A0	NOZZLE FOR SILICON GUN	1.200	PZ																																		
VM1059A1	HEAT SHRINK FILM H800	1.700	M																																		
VT1254A0	OUTER GLASS XB89- XC89-	1	PZ																																		
			KVT1254A	XB89- XV893 EXTERNAL GLASS KIT	<table border="1"> <thead> <tr> <th>Code</th> <th>Description</th> <th>Qty</th> <th>UOM</th> </tr> </thead> <tbody> <tr> <td>0H6575A1</td> <td>XB89- XV EXTERNAL GLASS HOLDING PROFILE</td> <td>2</td> <td>PZ</td> </tr> <tr> <td>IP1385A1</td> <td>CORNER POLYSTYRENE PACKING 110X80X2000</td> <td>2.180</td> <td>M</td> </tr> <tr> <td>IP1508A0</td> <td></td> <td>1.270</td> <td>PZ</td> </tr> <tr> <td>IP1508A1</td> <td>POLYSTYRENE U SHAPED PROFILE 2000X60X60</td> <td>1.270</td> <td>M</td> </tr> <tr> <td>SL1155A1</td> <td>SILICON BICOMPONENT LOCTITE</td> <td>0.200</td> <td>ML</td> </tr> <tr> <td>SL1156A0</td> <td>NOZZLE FOR SILICON GUN</td> <td>1</td> <td>PZ</td> </tr> <tr> <td>VT1254A0</td> <td>OUTER GLASS XB89- XC89-</td> <td>1</td> <td>PZ</td> </tr> </tbody> </table>	Code	Description	Qty	UOM	0H6575A1	XB89- XV EXTERNAL GLASS HOLDING PROFILE	2	PZ	IP1385A1	CORNER POLYSTYRENE PACKING 110X80X2000	2.180	M	IP1508A0		1.270	PZ	IP1508A1	POLYSTYRENE U SHAPED PROFILE 2000X60X60	1.270	M	SL1155A1	SILICON BICOMPONENT LOCTITE	0.200	ML	SL1156A0	NOZZLE FOR SILICON GUN	1	PZ	VT1254A0	OUTER GLASS XB89- XC89-	1	PZ
Code	Description	Qty	UOM																																		
0H6575A1	XB89- XV EXTERNAL GLASS HOLDING PROFILE	2	PZ																																		
IP1385A1	CORNER POLYSTYRENE PACKING 110X80X2000	2.180	M																																		
IP1508A0		1.270	PZ																																		
IP1508A1	POLYSTYRENE U SHAPED PROFILE 2000X60X60	1.270	M																																		
SL1155A1	SILICON BICOMPONENT LOCTITE	0.200	ML																																		
SL1156A0	NOZZLE FOR SILICON GUN	1	PZ																																		
VT1254A0	OUTER GLASS XB89- XC89-	1	PZ																																		

COMPONENT			SPARE PART																																														
Code	Description	Image	Code	Description	Components list																																												
VM2000A	M4 SOCKET HEAD SCREW COVER		VM2000A0	M4 SOCKET HEAD SCREW COVER																																													
CR1085A	INTERNAL GLASS UPPER HINGE		KVM0012A	4-5-5E S. INT. GLASS OPENING SYSTEM KIT	<table border="1"> <thead> <tr> <th>Code</th> <th>Description</th> <th>Qty</th> <th>UOM</th> </tr> </thead> <tbody> <tr> <td>CR1085A0</td> <td>INTERNAL GLASS UPPER HINGE</td> <td>1</td> <td>PZ</td> </tr> <tr> <td>CR1086A0</td> <td>INTERNAL GLASS LOWER HINGE</td> <td>1</td> <td>PZ</td> </tr> <tr> <td>GN1181A0</td> <td>INTERNAL GLASS HINGE SEAL</td> <td>2</td> <td>PZ</td> </tr> <tr> <td>VI1220A1</td> <td>4,2X12 TCB SELF-TAPPIN G SCREW</td> <td>5</td> <td>PZ</td> </tr> <tr> <td>VI1300A0</td> <td>SCREW M6X12 T1/2T+INOX</td> <td>4</td> <td>PZ</td> </tr> <tr> <td>VI1810A0</td> <td>M6X6 STAINLESS STEEL FLATHEAD SCREW</td> <td>6</td> <td>PZ</td> </tr> <tr> <td>VI1950A0</td> <td>ST. STEEL 4,2X13 TCB SELF-DRILLIN G SCREW</td> <td>6</td> <td>PZ</td> </tr> <tr> <td>VM1680A0</td> <td>INTERNAL GLASS HINGE</td> <td>2</td> <td>PZ</td> </tr> <tr> <td>VM2042A0</td> <td>INTERNAL GLASS LATERAL LOCKING SYSTEM</td> <td>2</td> <td>PZ</td> </tr> <tr> <td>VM2043A0</td> <td>UPPER - LOWER GLASS SUPPORT</td> <td>2</td> <td>PZ</td> </tr> </tbody> </table>	Code	Description	Qty	UOM	CR1085A0	INTERNAL GLASS UPPER HINGE	1	PZ	CR1086A0	INTERNAL GLASS LOWER HINGE	1	PZ	GN1181A0	INTERNAL GLASS HINGE SEAL	2	PZ	VI1220A1	4,2X12 TCB SELF-TAPPIN G SCREW	5	PZ	VI1300A0	SCREW M6X12 T1/2T+INOX	4	PZ	VI1810A0	M6X6 STAINLESS STEEL FLATHEAD SCREW	6	PZ	VI1950A0	ST. STEEL 4,2X13 TCB SELF-DRILLIN G SCREW	6	PZ	VM1680A0	INTERNAL GLASS HINGE	2	PZ	VM2042A0	INTERNAL GLASS LATERAL LOCKING SYSTEM	2	PZ	VM2043A0	UPPER - LOWER GLASS SUPPORT	2	PZ
Code	Description	Qty	UOM																																														
CR1085A0	INTERNAL GLASS UPPER HINGE	1	PZ																																														
CR1086A0	INTERNAL GLASS LOWER HINGE	1	PZ																																														
GN1181A0	INTERNAL GLASS HINGE SEAL	2	PZ																																														
VI1220A1	4,2X12 TCB SELF-TAPPIN G SCREW	5	PZ																																														
VI1300A0	SCREW M6X12 T1/2T+INOX	4	PZ																																														
VI1810A0	M6X6 STAINLESS STEEL FLATHEAD SCREW	6	PZ																																														
VI1950A0	ST. STEEL 4,2X13 TCB SELF-DRILLIN G SCREW	6	PZ																																														
VM1680A0	INTERNAL GLASS HINGE	2	PZ																																														
VM2042A0	INTERNAL GLASS LATERAL LOCKING SYSTEM	2	PZ																																														
VM2043A0	UPPER - LOWER GLASS SUPPORT	2	PZ																																														
			KCR1085A	INTERNAL GLASS UPPER HINGE KIT	<table border="1"> <thead> <tr> <th>Code</th> <th>Description</th> <th>Qty</th> <th>UOM</th> </tr> </thead> <tbody> <tr> <td>CR1085A0</td> <td>INTERNAL GLASS UPPER HINGE</td> <td>1</td> <td>PZ</td> </tr> <tr> <td>GN1181A0</td> <td>INTERNAL GLASS HINGE SEAL</td> <td>1</td> <td>PZ</td> </tr> <tr> <td>VI1810A0</td> <td>M6X6 STAINLESS STEEL FLATHEAD SCREW</td> <td>3</td> <td>PZ</td> </tr> </tbody> </table>	Code	Description	Qty	UOM	CR1085A0	INTERNAL GLASS UPPER HINGE	1	PZ	GN1181A0	INTERNAL GLASS HINGE SEAL	1	PZ	VI1810A0	M6X6 STAINLESS STEEL FLATHEAD SCREW	3	PZ																												
Code	Description	Qty	UOM																																														
CR1085A0	INTERNAL GLASS UPPER HINGE	1	PZ																																														
GN1181A0	INTERNAL GLASS HINGE SEAL	1	PZ																																														
VI1810A0	M6X6 STAINLESS STEEL FLATHEAD SCREW	3	PZ																																														

COMPONENT			SPARE PART																																		
Code	Description	Image	Code	Description	Components list																																
GN1181A	INTERNAL GLASS HINGE SEAL		KGN1181A	INT. GLASS HINGE GASKET 2 PCS KIT	<table border="1"> <thead> <tr> <th>Code</th> <th>Description</th> <th>Qty</th> <th>UOM</th> </tr> </thead> <tbody> <tr> <td>GN1181A0</td> <td>INTERNAL GLASS HINGE SEAL</td> <td>2</td> <td>PZ</td> </tr> </tbody> </table>	Code	Description	Qty	UOM	GN1181A0	INTERNAL GLASS HINGE SEAL	2	PZ																								
Code	Description	Qty	UOM																																		
GN1181A0	INTERNAL GLASS HINGE SEAL	2	PZ																																		
VM2000A	M4 SOCKET HEAD SCREW COVER		VM2000A0	M4 SOCKET HEAD SCREW COVER																																	
GN1181A	INTERNAL GLASS HINGE SEAL		KGN1181A	INT. GLASS HINGE GASKET 2 PCS KIT	<table border="1"> <thead> <tr> <th>Code</th> <th>Description</th> <th>Qty</th> <th>UOM</th> </tr> </thead> <tbody> <tr> <td>GN1181A0</td> <td>INTERNAL GLASS HINGE SEAL</td> <td>2</td> <td>PZ</td> </tr> </tbody> </table>	Code	Description	Qty	UOM	GN1181A0	INTERNAL GLASS HINGE SEAL	2	PZ																								
Code	Description	Qty	UOM																																		
GN1181A0	INTERNAL GLASS HINGE SEAL	2	PZ																																		
CR1086A	INTERNAL GLASS LOWER HINGE		KVM0012A	4-5-5E S. INT. GLASS OPENING SYSTEM KIT	<table border="1"> <thead> <tr> <th>Code</th> <th>Description</th> <th>Qty</th> <th>UOM</th> </tr> </thead> <tbody> <tr> <td>CR1085A0</td> <td>INTERNAL GLASS UPPER HINGE</td> <td>1</td> <td>PZ</td> </tr> <tr> <td>CR1086A0</td> <td>INTERNAL GLASS LOWER HINGE</td> <td>1</td> <td>PZ</td> </tr> <tr> <td>GN1181A0</td> <td>INTERNAL GLASS HINGE SEAL</td> <td>2</td> <td>PZ</td> </tr> <tr> <td>VI1220A1</td> <td>4,2X12 TCB SELF-TAPPING SCREW</td> <td>5</td> <td>PZ</td> </tr> <tr> <td>VI1300A0</td> <td>SCREW M6X12 T1/2T+INOX</td> <td>4</td> <td>PZ</td> </tr> <tr> <td>VI1810A0</td> <td>M6X6 STAINLESS STEEL FLATHEAD SCREW</td> <td>6</td> <td>PZ</td> </tr> <tr> <td>VI1950A0</td> <td>ST. STEEL 4,2X13 TCB SELF-DRILLING SCREW</td> <td>6</td> <td>PZ</td> </tr> </tbody> </table>	Code	Description	Qty	UOM	CR1085A0	INTERNAL GLASS UPPER HINGE	1	PZ	CR1086A0	INTERNAL GLASS LOWER HINGE	1	PZ	GN1181A0	INTERNAL GLASS HINGE SEAL	2	PZ	VI1220A1	4,2X12 TCB SELF-TAPPING SCREW	5	PZ	VI1300A0	SCREW M6X12 T1/2T+INOX	4	PZ	VI1810A0	M6X6 STAINLESS STEEL FLATHEAD SCREW	6	PZ	VI1950A0	ST. STEEL 4,2X13 TCB SELF-DRILLING SCREW	6	PZ
Code	Description	Qty	UOM																																		
CR1085A0	INTERNAL GLASS UPPER HINGE	1	PZ																																		
CR1086A0	INTERNAL GLASS LOWER HINGE	1	PZ																																		
GN1181A0	INTERNAL GLASS HINGE SEAL	2	PZ																																		
VI1220A1	4,2X12 TCB SELF-TAPPING SCREW	5	PZ																																		
VI1300A0	SCREW M6X12 T1/2T+INOX	4	PZ																																		
VI1810A0	M6X6 STAINLESS STEEL FLATHEAD SCREW	6	PZ																																		
VI1950A0	ST. STEEL 4,2X13 TCB SELF-DRILLING SCREW	6	PZ																																		

COMPONENT			SPARE PART																						
Code	Description	Image	Code	Description	Components list																				
CR1086A	INTERNAL GLASS LOWER HINGE		KVM0012A	4-5-5E S. INT. GLASS OPENING SYSTEM KIT	<table border="1"> <thead> <tr> <th>Code</th> <th>Description</th> <th>Qty</th> <th>UOM</th> </tr> </thead> <tbody> <tr> <td>VM1680A0</td> <td>INTERNAL GLASS HINGE</td> <td>2</td> <td>PZ</td> </tr> <tr> <td>VM2042A0</td> <td>INTERNAL GLASS LATERAL LOCKING SYSTEM</td> <td>2</td> <td>PZ</td> </tr> <tr> <td>VM2043A0</td> <td>UPPER - LOWER GLASS SUPPORT</td> <td>2</td> <td>PZ</td> </tr> </tbody> </table>	Code	Description	Qty	UOM	VM1680A0	INTERNAL GLASS HINGE	2	PZ	VM2042A0	INTERNAL GLASS LATERAL LOCKING SYSTEM	2	PZ	VM2043A0	UPPER - LOWER GLASS SUPPORT	2	PZ				
			Code	Description	Qty	UOM																			
VM1680A0	INTERNAL GLASS HINGE	2	PZ																						
VM2042A0	INTERNAL GLASS LATERAL LOCKING SYSTEM	2	PZ																						
VM2043A0	UPPER - LOWER GLASS SUPPORT	2	PZ																						
KCR1086A	INTERNAL GLASS LOWER HINGE KIT	<table border="1"> <thead> <tr> <th>Code</th> <th>Description</th> <th>Qty</th> <th>UOM</th> </tr> </thead> <tbody> <tr> <td>CR1086A0</td> <td>INTERNAL GLASS LOWER HINGE</td> <td>1</td> <td>PZ</td> </tr> <tr> <td>GN1181A0</td> <td>INTERNAL GLASS HINGE SEAL</td> <td>1</td> <td>PZ</td> </tr> <tr> <td>VI1810A0</td> <td>M6X6 STAINLESS STEEL FLATHEAD SCREW</td> <td>3</td> <td>PZ</td> </tr> </tbody> </table>	Code	Description	Qty	UOM	CR1086A0	INTERNAL GLASS LOWER HINGE	1	PZ	GN1181A0	INTERNAL GLASS HINGE SEAL	1	PZ	VI1810A0	M6X6 STAINLESS STEEL FLATHEAD SCREW	3	PZ							
Code	Description	Qty	UOM																						
CR1086A0	INTERNAL GLASS LOWER HINGE	1	PZ																						
GN1181A0	INTERNAL GLASS HINGE SEAL	1	PZ																						
VI1810A0	M6X6 STAINLESS STEEL FLATHEAD SCREW	3	PZ																						
VT1140A	XB893/895 XBC804/805 INTERNAL GLASS		KVT1140A	XB893/895 XBC804/805 INTERNAL GLASS KI	<table border="1"> <thead> <tr> <th>Code</th> <th>Description</th> <th>Qty</th> <th>UOM</th> </tr> </thead> <tbody> <tr> <td>IP1508A0</td> <td></td> <td>2</td> <td>PZ</td> </tr> <tr> <td>IP1508A1</td> <td>POLYSTYREN E U SHAPED PROFILE 2000X60X60</td> <td>2</td> <td>M</td> </tr> <tr> <td>VM1059A1</td> <td>HEAT SHRINK FILM H800</td> <td>1.500</td> <td>M</td> </tr> <tr> <td>VT1140A0</td> <td>XB893/895 XBC804/805 INTERNAL GLASS</td> <td>1</td> <td>PZ</td> </tr> </tbody> </table>	Code	Description	Qty	UOM	IP1508A0		2	PZ	IP1508A1	POLYSTYREN E U SHAPED PROFILE 2000X60X60	2	M	VM1059A1	HEAT SHRINK FILM H800	1.500	M	VT1140A0	XB893/895 XBC804/805 INTERNAL GLASS	1	PZ
			Code	Description	Qty	UOM																			
			IP1508A0		2	PZ																			
			IP1508A1	POLYSTYREN E U SHAPED PROFILE 2000X60X60	2	M																			
VM1059A1	HEAT SHRINK FILM H800	1.500	M																						
VT1140A0	XB893/895 XBC804/805 INTERNAL GLASS	1	PZ																						